



1U

JUST  
ONE  
USE



by Surgitrac<sup>®</sup>  
Europe

OPHTHALMOLOGY . OPHTALMOLOGIE . OPHTHALMOLOGIE



We are an established manufacturer and distributor of single-use ophthalmic surgical instruments, and procedure packs.

**We sell our products using a global network, of authorised distributors.**

**We offer :**

- Quality assured, CE marked products, manufactured to internationally recognised standards.
- ISO 13485:2016 certified manufacturing.
- Transparency in our supply chain : no forced, or child labour is used during our manufacturing.
- A continuous supply of products, due to our capacity to manufacture millions of instruments each year.
- Private label manufacturing.
- Over 10 years' experience in the manufacture of surgical instruments.
- Customer support.

[www.surgitrac.com](http://www.surgitrac.com)

*Medical devices intended for healthcare professionals only.  
For proper use of these devices, please refer to the instructions for use.*





Nous sommes distributeur d'instruments chirurgicaux ophtalmiques à usage unique, et de packs de procédures.

**Nous vendons nos produits en utilisant un réseau mondial de distributeurs agréés.**

**Nous offrons :**

- Un partenariat privilégié et exclusif avec le fabricant Surgitrac Instruments,
- Qualité garantie, produits marqués CE, fabriqués selon des normes internationalement reconnues,
- Notre expérience dans la distribution d'instruments chirurgicaux,
- Un support client à votre écoute.

**[www.just-one-use.com](http://www.just-one-use.com)**

*Dispositifs médicaux à destination des professionnels de santé. Pour un bon usage de ces dispositifs, merci de vous reporter aux notices d'utilisation.*



Wir sind ein etablierter Vertrieb für ophthalmologische, chirurgische Instrumente und Packs.

**Wir vertreiben unsere Produkte über unser globales Netzwerk ausgesuchter Distributoren.**

**Wir bieten :**

- Eine privilegierte und exklusive Partnerschaft mit Surgitrac Instruments Hersteller,
- Sichere Qualität, CE zertifiziert, hergestellt nach internationalen anerkannten Standards,
- Unsere Erfahrung im Vertrieb von chirurgischen Instrumenten,
- Kundenbetreuung ansässig.

**[www.just-one-use.com](http://www.just-one-use.com)**

*Medizinprodukte für medizinisches Fachpersonal. Für die ordnungsgemäße Verwendung dieser Geräte lesen Sie bitte die Gebrauchsanweisung.*

# JUST ONE USE

## PHACO, REFRACTIVE & CORNEA

 **SUMMARY** | SOMMAIRE  
INHALTSVERZEICHNIS

|  |       |             |
|--|-------|-------------|
| <b>1/ CAPSULORHEXIS</b><br>CAPSULORHEXIS<br>KAPSULORHEXIS                                    | ..... | PAGES 06-07 |
| <b>2/ FORCEPS</b><br>PINCES<br>PINZETTEN   | ..... | PAGES 08-17 |
| <b>3/ MANIPULATORS &amp; CHOPPERS</b><br>MANIPULATEURS & CHOPPERS<br>MANIPULATOREN & CHOPPER | ..... | PAGES 18-24 |
| <b>4/ SPECULUMS</b><br>BLEPHAROSTATS<br>LIDSPERRER   | ..... | PAGES 25-30 |
| <b>5/ SCISSORS</b><br>CISEAUX<br>SCHEREN   | ..... | PAGES 31-36 |

## 6/ MEASURERS & MARKERS

MESUREURS & MARQUEURS  
MESSINSTRUMENTE & MARKER

PAGES 37-39

## 7/ CURETTES & CLAMPS

CURETTES & PINCES  
KÜRETTEN & KLEMMEN

PAGES 40-41

## 8/ NEEDLE HOLDERS

PORTE-AIGUILLES  
NADELHALTER

PAGES 42-43

## 9/ LACRIMAL

LACRYMAL  
LAKRIMAL

PAGES 44-46

## 10/ CORNEAL & REFRACTIVE

CORNÉE & RÉFRACTIVE  
KORNEAL & REFRAKTIV

PAGES 47-54

## 11/ GENERAL OPHTHALMIC

OPHTALMOLOGIE GÉNÉRALE  
ALLGEMEINE OPHTHALMOLOGIE

PAGES 54-59



**Just One Use** // *The acronym « Just One Use » affirms the single use characteristic of our instruments.* **Safety** : reduce the risk of cross-contamination. **Economy** : eliminate the costs of repair and sterilization. **Performance** : manufactured from medical grade stainless steel, our single use instruments have the same grip, weight and balance of reusable instruments. **Convenience** : reduce theatre preparation time, presentation in sets or individually.

# CAPSULORHEXIS / capsulorhexis / kapsulorhexis

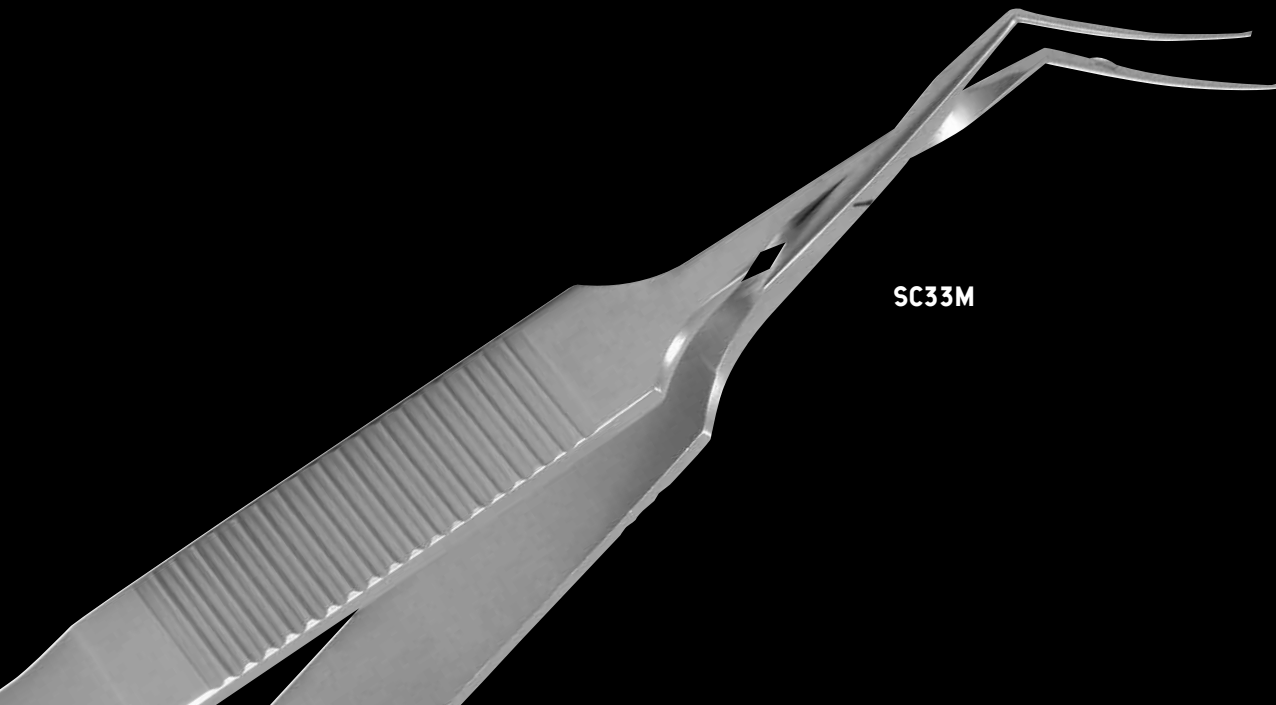

## MICS CAPSULORHEXIS FORCEPS CROSS ACTION

Pince Capsulorhexis Action Croisée, Courbe  
MICS Kapsulorhexispinzette Cross Action (x-Action)

**Length : 115 mm**  
**Handle length : 84 mm**  
**50° angled**  
**1.8 mm incision**

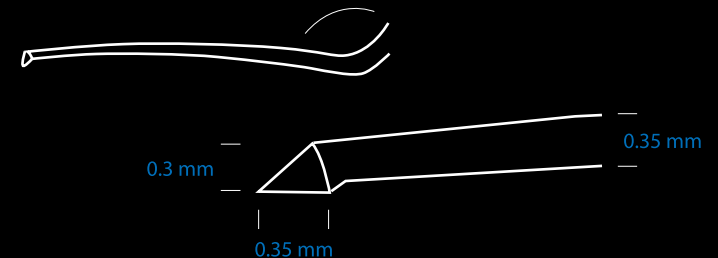

**CAPSULORHEXIS ROUND BODIED CURVED** / Pince Capsulorhexis, Manche Rond, Courbe / Kapsulorhexispinzette, gebogen, runder Griff

**Length : 105 mm**  
**Handle length : 77 mm**  
**45° angled platform with notched tips 0.3 mm**  
**1.8 mm incision**

**SC34M**



CAPSULORHEXIS

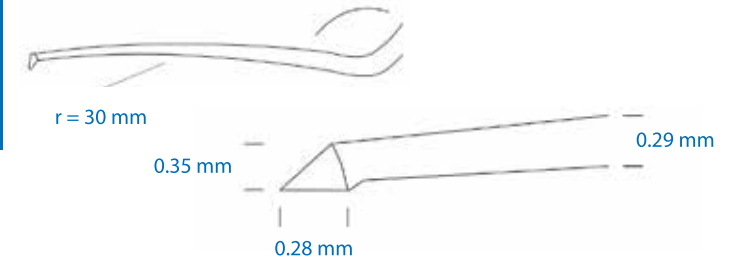

**MICS CAPSULORHEXIS FORCEPS CURVED** / Pince Capsulorhexis MICS, Courbe / MICS Kapsulorhexispinzette, gebogen

**Length : 105 mm**  
**Handle length : 77 mm**  
**45° angle**  
**12 mm platform**  
**0.3 mm tips**  
**1.8 mm incision**

**SC29M**



CAPSULORHEXIS



**MICS CAPSULORHEXIS FORCEPS ROUND BODIED CURVED** / Pince Capsulorhexis, Manche rond / Kapsulorhexispinzette, runder Griff

**Length : 105 mm**  
**Handle length : 77 mm**  
**50° angle 0.2 mm tip**  
**12 mm platform**  
**1.8 mm incision**

**SC134M**

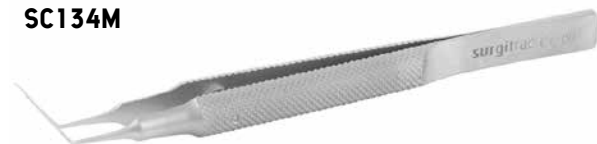

CAPSULORHEXIS

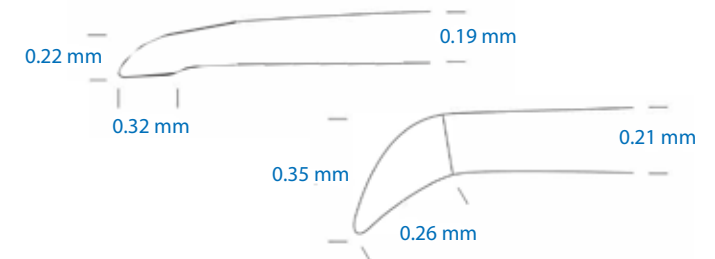

**MICS CAPSULORHEXIS FORCEPS STRAIGHT** / Pince Capsulorhexis MICS Droite, Kystitome / MICS Kapsulorhexispinzette, gerade

**Length : 105 mm**  
**Handle length : 76 mm**  
**45° angled 0.3 mm notched tips, with 11 mm platform**  
**1.8 mm incision**

**SC133M**



CAPSULORHEXIS

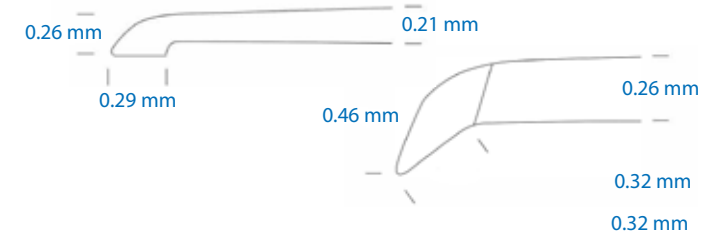

**Just One Use** // Le sigle « *Just One Use* » affirme le caractère usage unique de nos instruments. **Sécurité** : réduire le risque de contamination croisée. **Économie** : éliminer les coûts de réparation et de re-stérilisation. **Performance** : usinés en acier inoxydable de grade médical, nos instruments à usage unique offrent une ergonomie, un poids et un équilibre équivalents aux instruments re-stérilisables. **Praticité** : réduire le temps de préparation au bloc, présentation en sets ou à l'unité.

## FORCEPS / Pincés / Pinzetten

 **FIXATION** | **GENERAL** | **LENS** | **TYING**





ADSONS DISSECTION FORCEPS / Pince d'Adson à Griffes / Adson Dissektionspinzette

Length : 125 mm  
Handle length : 97 mm  
1 into 2 teeth  
28 mm platform

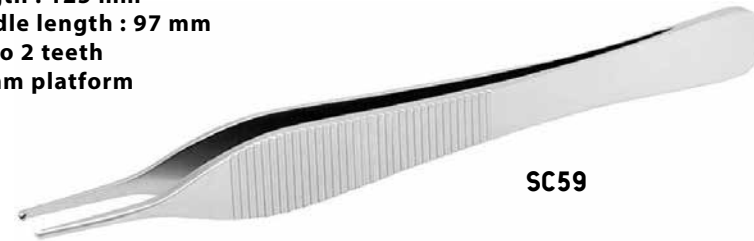

SC59

FIXATION

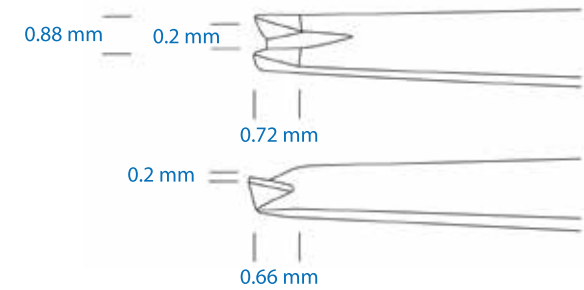

BISHOPS FORCEPS / Pince de Bishop / Bishops Pinzette

Length : 105 mm  
Handle length : 75 mm  
1 into 2 teeth



SC56

FIXATION



SWAN NECK TYPE PLAIN FORCEPS / Pince plate type col de cygne / Flache Pinzette mit Schwanenhals

Length : 114 mm  
Handle length : 79 mm



SC35

FIXATION

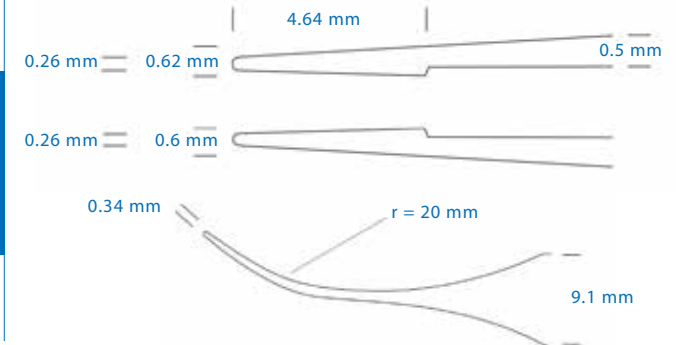

**BONN FORCEPS** / Pince de Bonn, à Griffes, Manche court / Irispinzette, Bonn, kurzer Griff

**Length : 85 mm**  
**Handle length : 57 mm**  
**1 into 2 teeth**  
**Short handle**  
**5 mm platform**

**SC38**



FIXATION

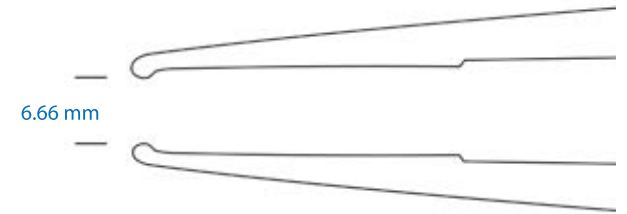

**BONN FORCEPS** / Pince de Bonn, à Griffes, Manche long / Irispinzette, Bonn, langer Griff

**Length : 105 mm**  
**Handle length : 76 mm**  
**1 into 2 teeth**  
**5 mm platform**

**SC129**



FIXATION

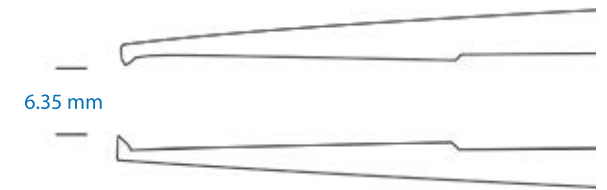

**COLIBRI TOOTHED FORCEPS** / Pince Colibri, à Griffes, Manche long / Kolibri Pinzette, gezahnt, langer Griff

**Length : 110 mm**  
**Handle length : 72 mm**  
**55° angled**  
**1 into 2 teeth**  
**4 mm platform**

**SC22**



FIXATION

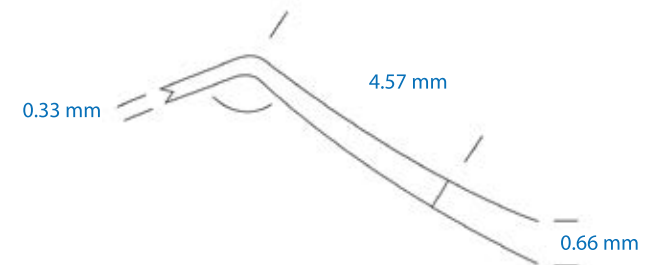

**COLIBRI TYING FORCEPS** / Pince Colibri, à Griffes, Manche court / Kolibri Pinzette, gezahnt, kurzer Griff

**Length : 85 mm**  
**Handle length : 59 mm**  
**55° angle forked tip**  
**Short handle**  
**4 mm platform**

**SC20**



FIXATION

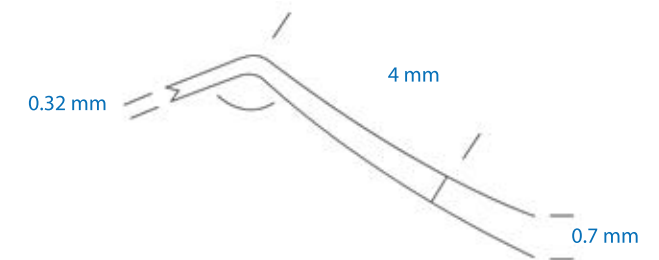

**FINE CLAW FORCEPS** / Pince à Griffes, Fine / Feine Greifpinzette

**Length : 100 mm**  
**Handle length : 68 mm**  
**2 into 1 teeth**  
**32 mm platform to tip**

**SC115**



FIXATION

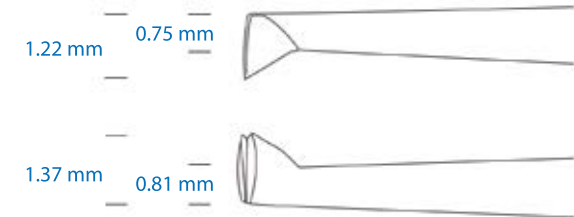

**HOSKINS FORCEPS** / Pince de Hoskins / Hoskins Pinzette

**Length : 85 mm**  
**Handle length : 56 mm**  
**Notched forceps**  
**5 mm platform**

**SC55**



FIXATION



**IRIS FORCEPS** / Pinces à iris, griffes fines / Irispinzette, gezahnt, sehr fein

**Length : 105 mm**  
**Handle length : 67 mm**  
**1 into 2 teeth**  
**5 mm platform**

**SC116**



FIXATION



**IRIS FORCEPS POINTED** / Pinces à iris, Extrémités pointues, Mors striés / Irispinzette, gerade, gerieft

**Length : 110 mm**  
**Handle length : 69 mm**  
**Serrated 15 mm platform**

**SC128**



FIXATION

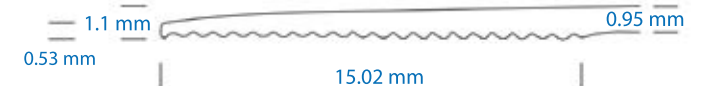

JAYLES FORCEPS / Pince de Jayles / Jayles Pinzette

**Length : 105 mm**  
**Handle length : 67 mm**  
**1 into 2 teeth**  
**5 mm platform**

SC117



FIXATION

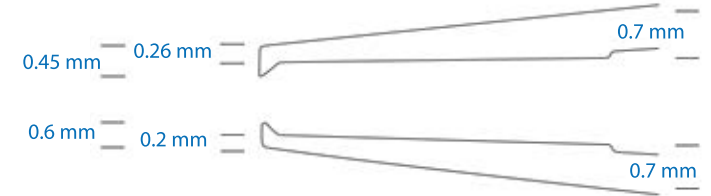

STRAIGHT NOTCHED FORCEPS (HOSKINS) / Pince à fixer alvéolée de Hoskins / Hoskins Pinzette gerade

**Length : 110 mm**  
**Handle length : 76 mm**  
**Notched forceps**  
**5 mm platform**

SC49



FIXATION

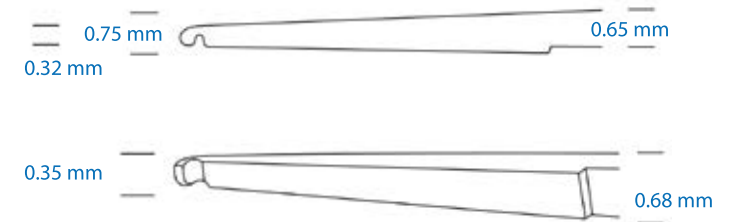

ST. MARTINS FORCEPS / Pince de Paufigue / St. Martins Pinzette

**Length : 84 mm**  
**Handle length : 56 mm**  
**1 into 2 teeth**  
**6 mm platform**

SC54



FIXATION

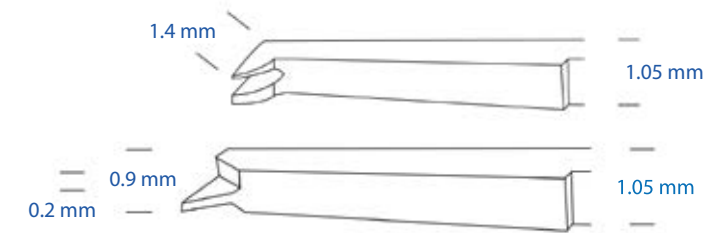

STRAIGHT TOOTHED FORCEPS FINE / Pince à Tissus, droite / Pinzette gerade, fein mit Zähnen

**Length : 105 mm**  
**Handle length : 78 mm**  
**1 into 2 teeth**  
**5 mm platform**

SC21



FIXATION

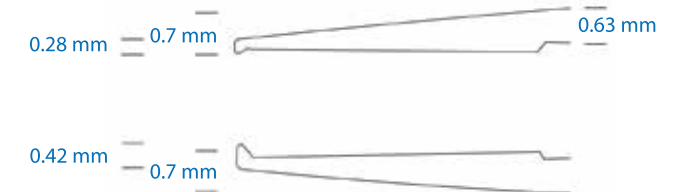

ADSONS FORCEPS / Pince d'Adson, Mors striés / Adson anatomische Pinzette, gerieft

Length : 125 mm  
 Handle length : 97 mm  
 14 mm serrated platform



SC119

GENERAL



ADSONS FORCEPS FINE SERRATED / Pince d'Adson, Striée, Fine / Adson anatomische Pinzette, gerieft, sehr fein

Length : 125 mm  
 Handle length : 98 mm  
 Serrated 14 mm tying platform



SC113

GENERAL

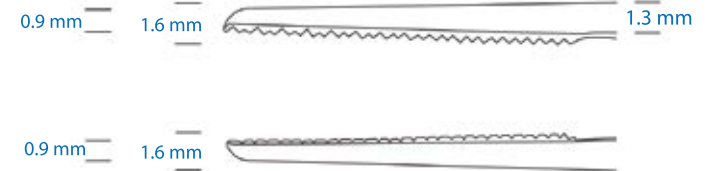

DENIS SCLERECTOMY FORCEPS / Pince à sclérectomie de Denis / Denis Sclerectomy Pinzette

Length : 105 mm  
 Handle length : 75 mm  
 30 mm pointed ends



SC104

GENERAL

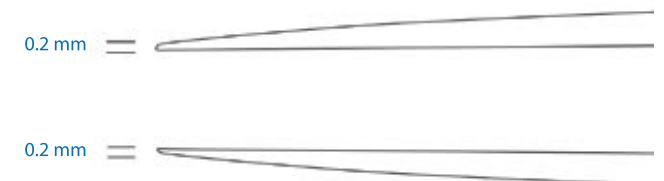

EPILATION - CILIA FORCEPS / Pince à Cil / Fremdkörper & Zilienpinzette

Length : 73 mm  
 50 mm platform



SC58

GENERAL

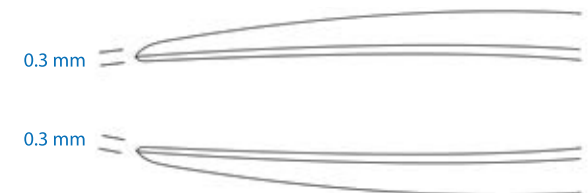

EPILATION FORCEPS / Pince à épiler / Zilien-und Fremdkörperpinzette

Length : 88 mm  
18 mm platform

SC127



GENERAL

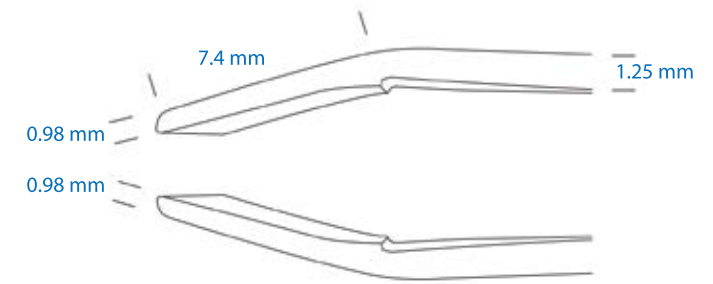

JEWELLERS FORCEPS / Pince de Joailler / Feine Fadenpinzette (Jewellers)

Length : 115 mm  
Handle length : 82 mm  
0.1 mm fine pointed ends  
32 mm platform

SC60



GENERAL

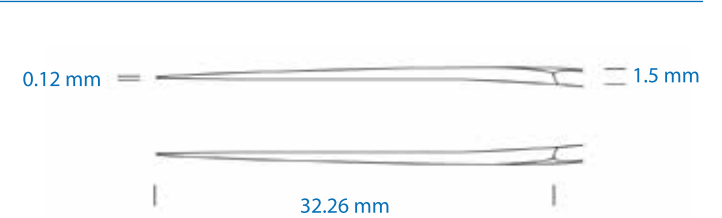

MOORFIELDS FORCEPS / Pince de Moorfield / Moorfield Pinzette

Length : 110 mm  
Handle length : 68 mm  
Serrated 15 mm platform

SA12



GENERAL

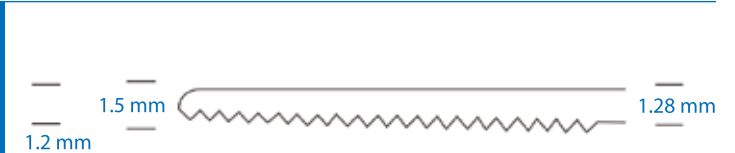

MOORFIELDS FORCEPS FINE / Pince de Moorfield Pointes fines / Moorfield Pinzette, fein

Length : 110 mm  
Handle length : 71 mm  
Serrated 15 mm platform

SA17



GENERAL

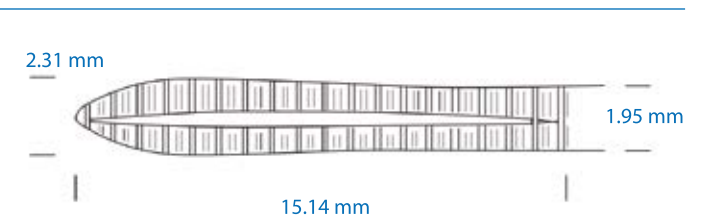

**MOSQUITO FORCEPS** / Pince Mosquito / Mosquito Pinzette

**Length : 130 mm**  
**Handle to tip : 98 mm**  
**22 mm serrated clamp area**

**SG02**



GENERAL

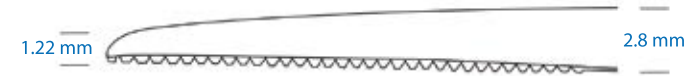

**IOL REMOVAL FORCEPS** / Pince à extraction d'implant / IOL Explantations Pinzette

**Length : 82 mm**  
**Handle length : 54 mm**  
**35° angled serrated tips**  
**13 mm platform**

**SC112**



LENS

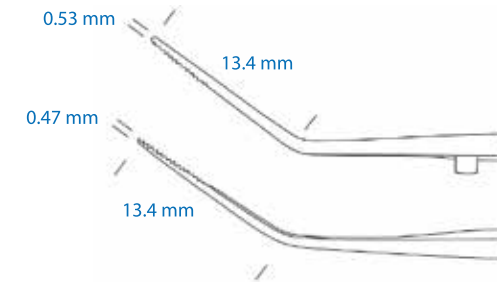

**LENS FOLDING FORCEPS** / Pince à implants / IOL Faltpinzette

**Length : 105 mm**  
**Handle length : 78 mm**  
**45° angled**  
**1 cm platform**

**SC51**



LENS

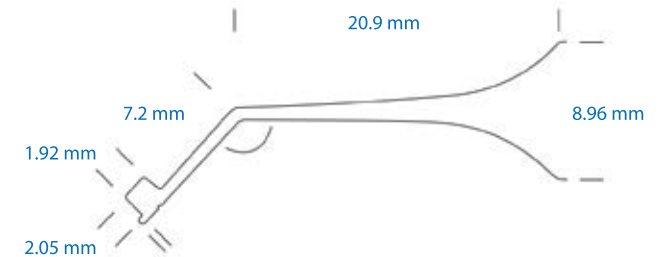

**LENS IMPLANTATION FORCEPS** / Pince à implantation IOL / IOL Implanations Pinzette

**Length : 105 mm**  
**Handle length : 76 mm**  
**45° angled tips**  
**10 mm platform**

**SC52**



LENS

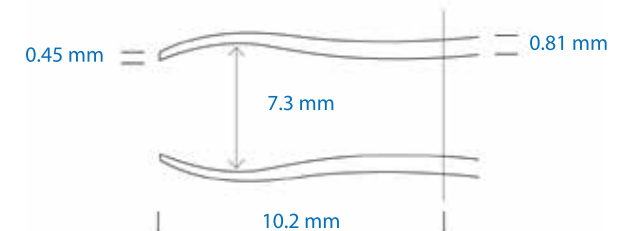

**KELMAN MC PHERSON FORCEPS** / Pince Kelman McPherson / Kelman Mc Pherson Pinzette

**Length : 83 mm**  
**Handle length : 57 mm**  
**50° angled 7 mm tying platform**



**SC73**

TYING



**MC PHERSON TYING FORCEPS** / Pince McPherson / Angewinkelte Fadenpinzette (McPherson)

**Length : 105 mm**  
**Handle length : 76 mm**  
**45° angled 5 mm tying platform**



**SC72**

TYING



**CURVED NOTCHED FORCEPS** / Pince courbe alvéolée / Gebogene chirurgische Pinzette

**Length : 100 mm**  
**Handle length : 76 mm**  
**Curved 5 mm tying platforms**



**SC50**

TYING

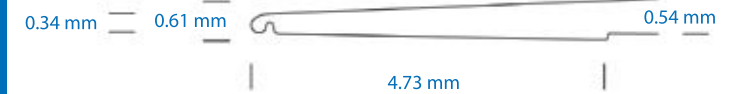

**STRAIGHT TYING FORCEPS** / Pince à fil droite, MC / Knüpf-/Fadenpinzette gerade

**Length : 85 mm**  
**Handle length : 56 mm**  
**5 mm tying platform**



**SC19**

TYING





**SUTURE REMOVAL FORCEPS CURVED** / Pince à sutures, courbe / Fadenpinzette zur Nahtentfernung, gebogen

**Length : 105 mm**  
**Handle length : 76 mm**  
**Pointed tips**  
**5 mm tying platform**

**SC120**



FIXATION

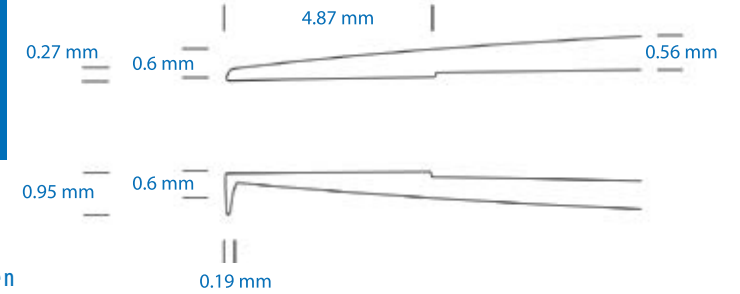

**TROUTMAN TYING FORCEPS CURVED** / Pince monofilament de Troutman / Knüpfpinzette nach Troutman, gebogen

**Length : 105 mm**  
**Handle length : 76 mm**  
**Curved tips**  
**5 mm tying platform**

**SC105**



TYING

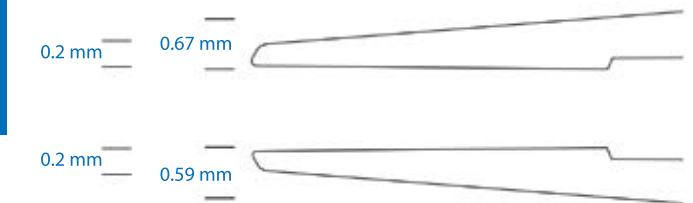

**STRAIGHT TYING FORCEPS** / Pince à fil droite, ML / Knüpf-/Fadenpinzette gerade

**Length : 105 mm**  
**Handle length : 75 mm**  
**5 mm tying platform**

**SC71**



TYING



**LINDGREN FORCEPS** / Pince de Lindgren / Lindgren Pinzette

**Superior rectus forceps Curved**  
**Length : 110 mm**  
**Handle length : 70 mm**  
**1 into 2 teeth**

**SC99**



TYING

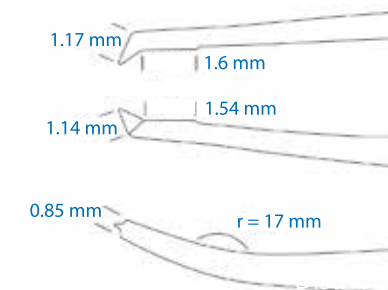

**Just One Use // Das Akronym « Just One Use » bestätigt die einzigartige Verwendung unserer Instrumente. Sicherheit :** Reduziert das Risiko einer Kreuzkontamination. **Wirtschaftlichkeit :** Kosten für Reparatur und Sterilisation entfallen. **Leistung :** Verwendung von medizinischem Stahl, Instrumente mit einzigartiger Ergonomie, Gewicht und Beschaffenheit, die äquivalent zu sterilisierbaren Instrumenten ist. **Komfort :** Verkürzung der Vorbereitungszeit, erhältlich als Sets oder Einzelinstrumente.

## MANIPULATORS & CHOPPERS

Manipulateurs & Choppers

Manipulatoren & Chopper

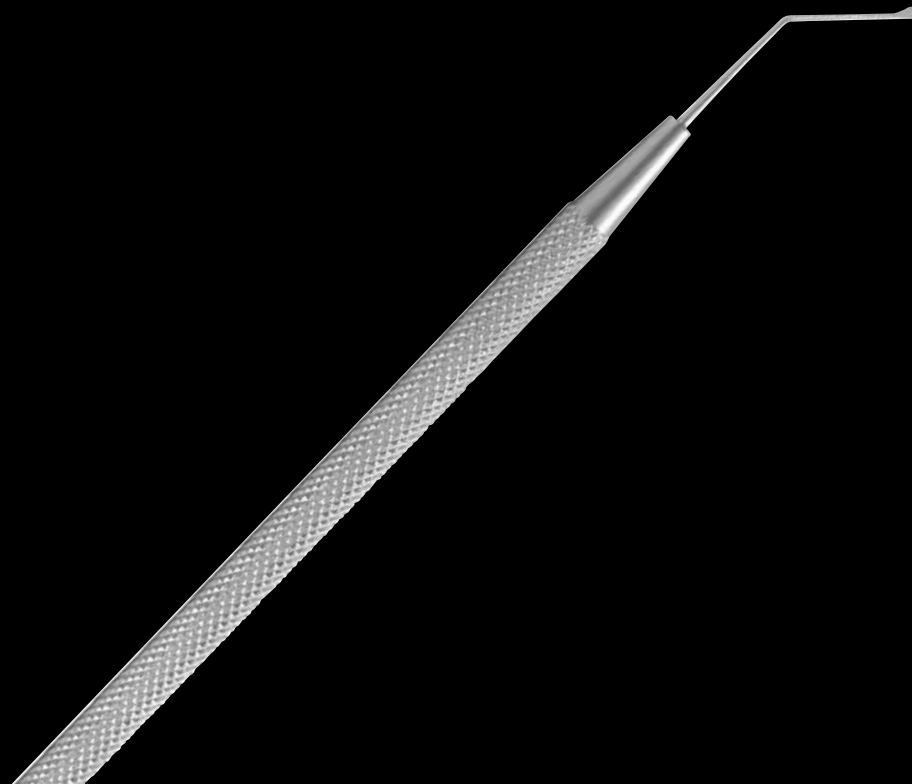

**CHOPPER AND DIALLER** / Double Manipulateur Chopper/Y / Chopper und Spalter

**Length : 120 mm**  
**Handle length : 76 mm**  
**45° angled ends**  
**One rounded tip and one 1 mm Y shaped end**  
**Round bodied**  
**Double ended**

**SC39**

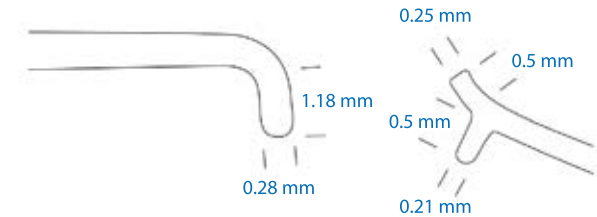

**DENIS CLEAVER** / Cliver de Denis / Denis Spalter

**Handle length : 95 mm**  
**0,3mm Curved Cleaver**  
**Tip angled left 30° from 11mm 45° angled shaft**  
**Round bodied**

**SC97**

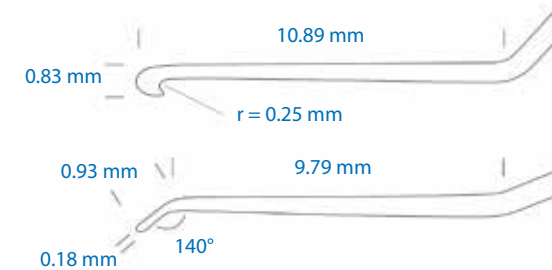

**GREENS CHOPPER** / Chopper de Greens / Greens Chopper

**Length : 115 mm**  
**Handle length : 95 mm**  
**30° angled top curved rounded hook**  
**Round bodied**

**SC45**

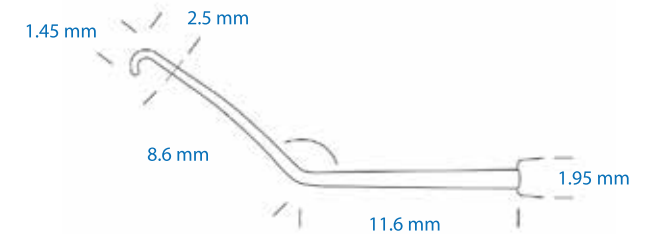

**GOVAN MANIPULATOR** / Manipulateur Govan / Govan Manipulator

**Length : 100 mm**  
**Handle length : 75 mm**  
**0.4 mm x 0.2 mm x 10.4 mm flattened tip**  
**60° angle pointed tip**  
**Round bodied**

**SC100**



GOVAN MANIPULATOR AND PHACO CHOPPER / Chopper Phaco & Manipulateur Govan / Govan Manipulator & Phako Chopper

**Length : 120 mm**  
**Handle length : 78 mm**  
**60° pointed end and 90° blunt end**  
**Round bodied**  
**Double ended**

**SC102**

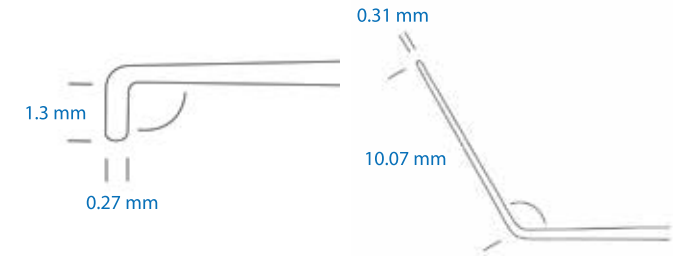

IRIS REPOSITOR / Manipulateur à iris / Iris Repositor

**Length : 130 mm**  
**Handle length : 98 mm**  
**Round bodied**

**SC63**

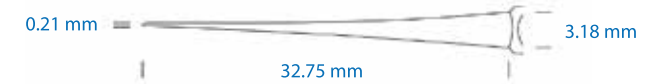

JONES CHOPPER / Chopper Jones / Jones Chopper

**Length : 120 mm**  
**Handle length : 95 mm**  
**45° angled pointed tip**  
**Round bodied**

**SC90**

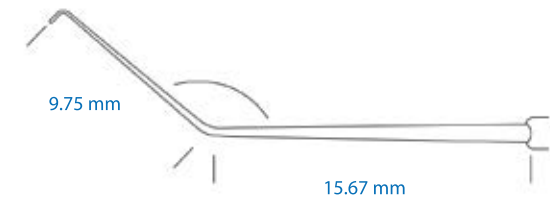

KOCH CHOPPER / Chopper Koch / Koch Chopper

**Length : 120 mm**  
**Handle length : 95 mm**  
**45° angled 1 mm rounded tip**  
**Round bodied**

**SC44**

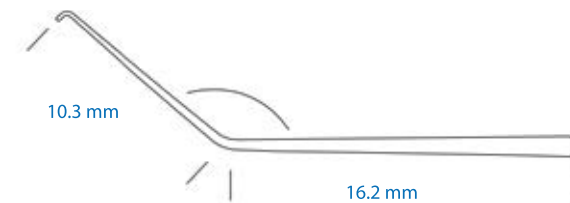

**KOCH PHACO SPATULA** / Spatule de Koch / Phako Spatel nach Koch

**Length : 120 mm**  
**Handle length : 96 mm**  
**Slight curved spatula**  
**Round bodied**

**SC143**

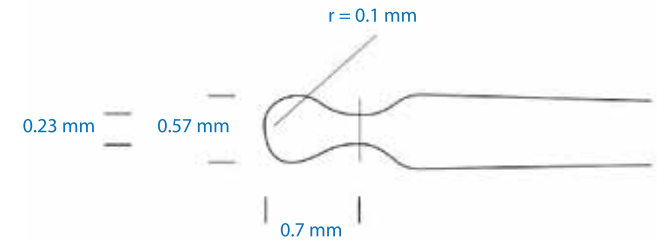

**KUGLEN HOOK** / Crochet de Kuglen / Häkchen nach Kuglen

**Length : 115 mm**  
**Handle length : 95 mm**  
**45° angled blunt, flat hooked tip**  
**Round bodied**

**SG15**



**LEBUISSON MANIPULATOR** / Manipulateur Lebuisson / Lebuisson Manipulator

**0.40 mm x 0.50 mm x 1.00 mm spatula tip**  
**Ø0.3 mm curved 12.6 mm**  
**90° angled shaft**  
**Length : 115 mm**  
**Handle length : 90 mm**  
**Round bodied**

**SC106**

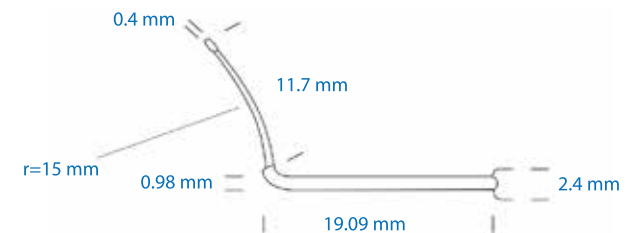

**LENS DIALER (SINSKEY HOOK)** / Crochet de Sinsky / Linsenhäkchen nach Sinsky

**Length : 120 mm**  
**Handle length : 95 mm**  
**35° angled**  
**Round bodied**

**SC46**



**LESTER HOOK** / Crochet de Lester / Lester Haken

**Handle length : 95 mm**  
**Ø0.25 mm ball on 0.4 mm finger**  
**10mm 45° angled shaft**  
**Length : 115 mm**  
**Handle length : 100 mm**  
**Round bodied**

**SC146**

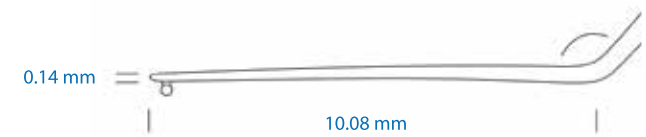

**PHACO CHOPPER AND MUSHROOM MANIPULATOR DOUBLE ENDED** / Manipulateur Double Chopper-Champignon / Phaco Chopper und Mushroom Manipulator (Kombi-Instrument)

**Length : 120 mm**  
**Handle length : 70 mm**  
**45° chopper**  
**Round bodied**  
**Double ended**

**SC147**

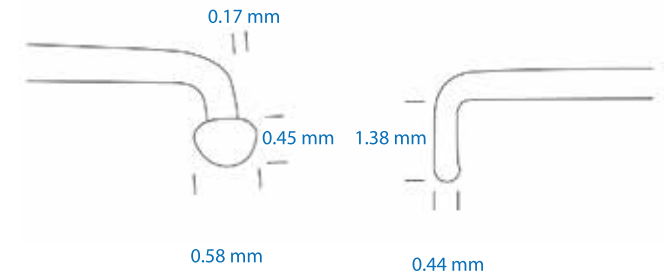

**PHACO CHOPPER** / Chopper Phaco / Phako Chopper

**Length : 120 mm**  
**Handle length : 95 mm**  
**40° angled round end**  
**Round bodied**

**SC43**

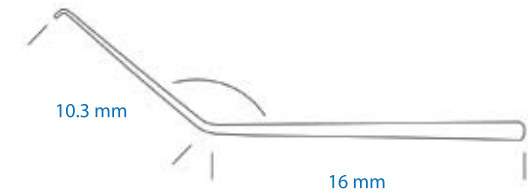

**PHACO CHOPPER CLAW** / Chopper Claw, fin / Phako Claw Chopper (krallen förmig, fein)

**Length : 120 mm**  
**Handle length : 95 mm**  
**40° angled tip, hooked tip**  
**Round bodied**

**SC42**



**PISACANO ROTATOR AND NEUHANN MANIPULATOR DOUBLE END** / Manipulateur double Pisacano-Neuhann / Pisacano-Neuhann Manipulator (Kombi-instrument)

**Length : 100 mm**  
**Handle length : 75 mm**  
**60° spatula end and 30° round end**  
**Round bodied**  
**Double ended**

**SC101**

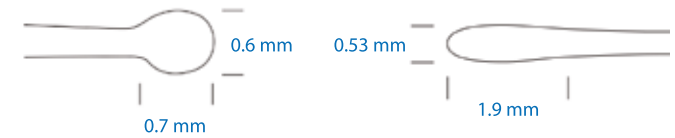

**SINSKEY HOOK AND GOVAN MANIPULATOR DOUBLE ENDED** / Manipulateur double Sinsky-Govan / Sinsky Håkchen und Govan Manipulator (Kombi-Instrument)

**Length : 120 mm**  
**Handle length : 76 mm**  
**60° manipulator and 45° hooked end**  
**Round bodied**  
**Double ended**

**SC144**

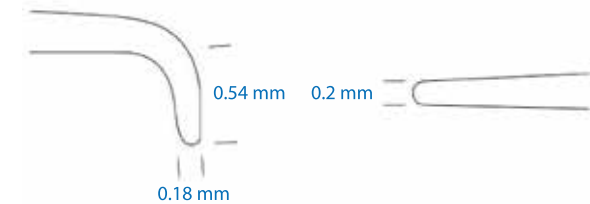

**MUSHROOM NUCLEUS MANIPULATOR** / Manipulateur champignon / Mushroom Nucleus Manipulator

**Length : 120 mm**  
**Handle length : 95 mm**  
**45° angled mushroom shaped tip**  
**Round bodied**

**SC48**

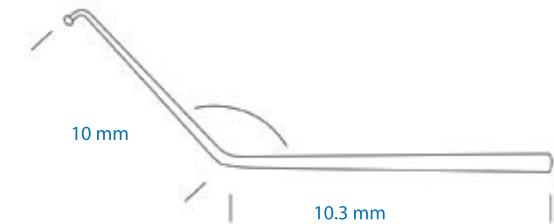

**Y SHAPED NUCLEUS ROTATOR** / Manipulateur de Noyau Y, Vertical / Y-Nucleus Rotator

**Length : 120 mm**  
**Handle length : 95 mm**  
**40° angled tip Y shaped end**  
**Round bodied**

**SC41**



CHOPPER AND KUGLEN HORIZONTAL DOUBLE ENDED / Manipulateur double Chopper/Kuglen / Kombi Manipulator Chopper/Kuglen

**Length : 127 mm**  
**Handle length : 70 mm**  
**60° spatula shaped chopper**  
**40° horizontal kuglen hook**



SC95

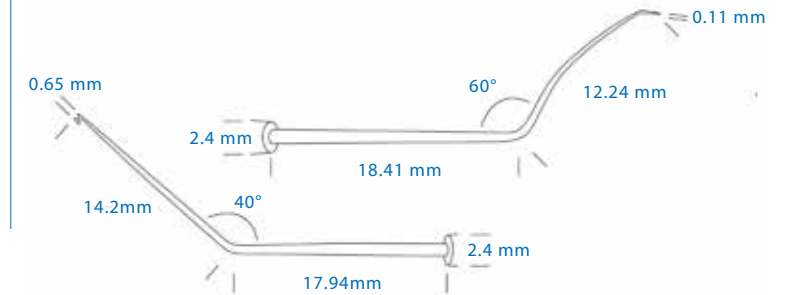

NAGAHARA CLEAVER / Chopper Nagahara / Nagahara Chopper

**Length : 117 mm**  
**Handle length : 91 mm**



SC148

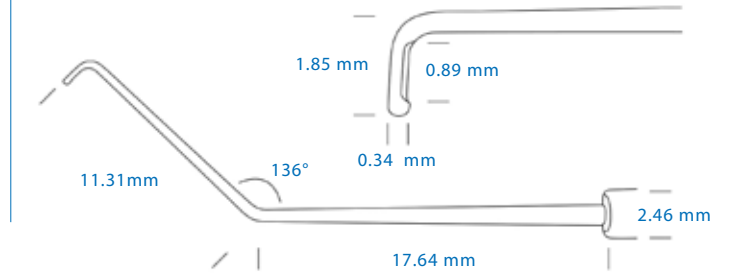

DRYSDALE NUCLEUS SPATULA / Manipulateur Drysdale / Drysdale Nukleus Manipulator

**Length : 110 mm**  
**Handle length : 95 mm**  
**45° angled paddle shaped tip**  
**Round bodied**



SC47

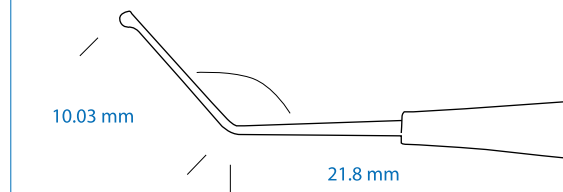



**Just Quality // Quality of manufacture and irreproachable ethics.**

Our instruments are CE marked and manufactured in compliance with current international standards. All our products are subject to rigorous quality testing throughout the design and manufacturing. We inspect each surgical instruments that we manufacture, and every instrument is hand finished. We strive to operate and behave in an ethical and responsible way.

# SPECULUMS / Blépharostats / Lidsperrer

 WIRE | MECHANICAL | PAEDIATRIC

## KRATZ CLOSED LOOP SPECULUM

Blépharostat temporal de Barraquer

Lidsperrer nach Barraquer, feiner gebogener Draht temporal offen

**Length : 32 mm**  
**50° angle at base**

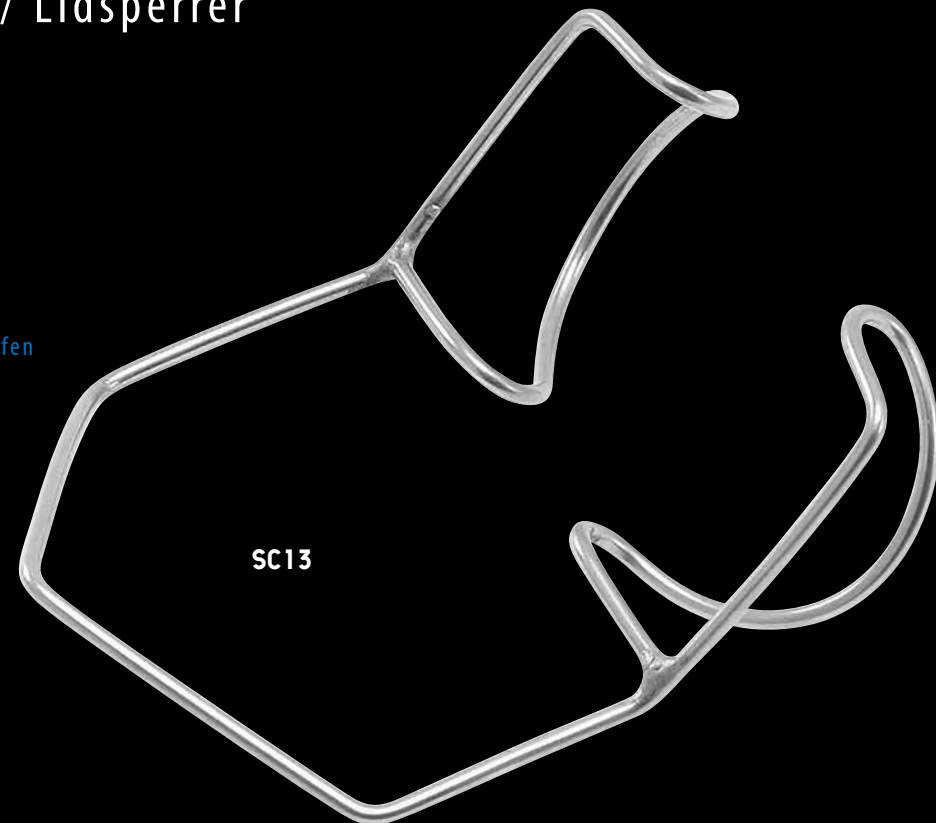
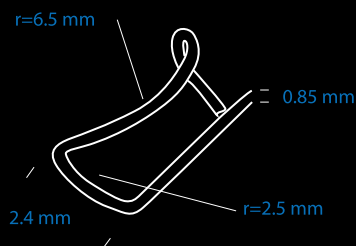

**BROAD GAUGE WIRE SPECULUM / Blépharostat fils large / Breiter Gauge Draht Lidsperrer**

**Length : 50 mm**  
**Width : 40 mm**

**SC01**



WIRE

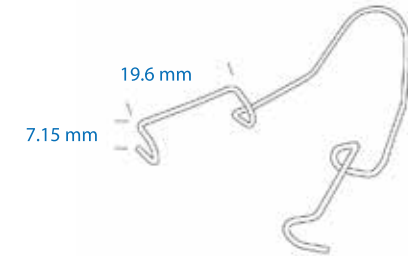

**CLOSED LOOP WIDE SPECULUM / Blépharostat anses fils large / Spekulum/Lidsperrer mit geschlossenen Valven**

**Length : 44 mm**  
**Width : 42 mm**

**SC07**



WIRE

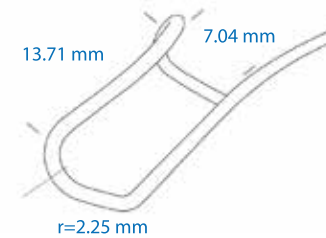

**HEAVY GAUGE WIRE SPECULUM OPEN LOOP / Blépharostat fil, grand diamètre / Drahtlidsperrer groß (Heavy Gauge), offen**

**Length : 72 mm**  
**Overall width : 58 mm**

**SC124**

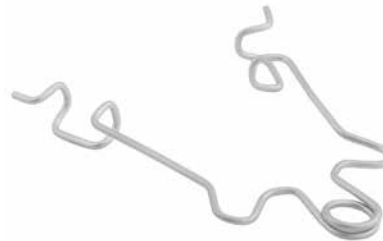

WIRE

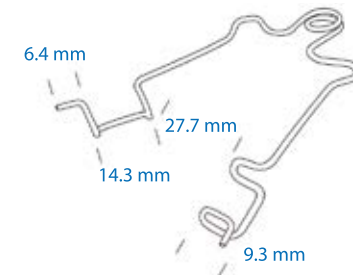

**KRATZ BARRAQUER CLOSED LOOP / Blépharostat de Barraquer, fenêtré / Lidsperrer nach Kratz , gefenstert**

**Length : 40 mm**  
**Width : 42 mm**

**SC09**

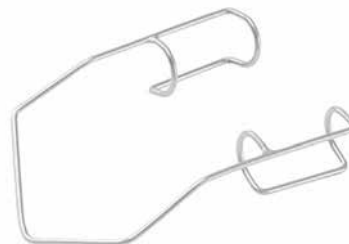

WIRE



**KRATZ BARRAQUER CLOSED LOOP SPECULUM** / Blépharostat Kratz-Barraquer, fenêtré / Lidsperrer Kratz-Barraquer, gefenstert

**Length : 43 mm**  
**50° angle at base**

**SC132**

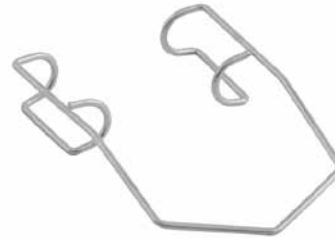

WIRE

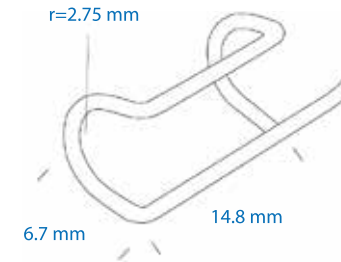

**KRATZ BARRAQUER WIRE SPECULUM OPEN LOOP** / Blépharostat Kratz-Barraquer, anses fil / Kratz-Barraquer Lidsperrer, feiner gebogener Draht temporal offen

**Length : 47 mm**  
**Width : 31 mm**  
**50° angle at base**

**SC11**

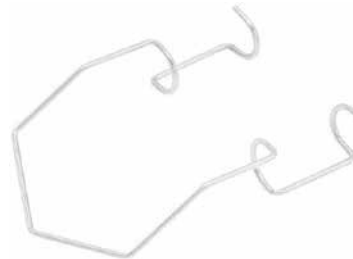

WIRE



**KRATZ OPEN LOOP WIRE SPECULUM (BLUE)** / Blepharostat de Kratz (bleu) / Kratz Lidsperrer mit offenen Valven (Blau)

**Length : 44 mm**  
**Overall width : 30 mm**  
**50° angle at base**

**SC107**



WIRE

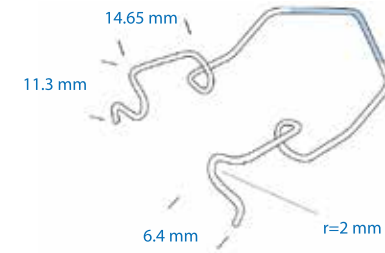

**WIRE SPECULUM OPEN LOOP** / Blepharostat Kratz-Barraquer fil, ouvert / Kratz-Barraquer Spekulum mit offenen Valven

**Length : 38 mm**  
**Overall width : 39 mm**  
**Wire width : 0.9 mm**

**SC150**



WIRE

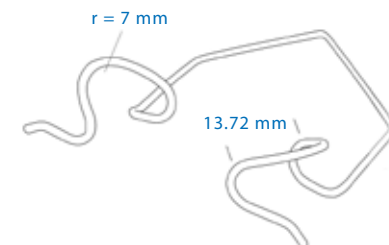

**KRATZ SOLID BLADED WIRE SPECULUM** / Blépharostat Kratz-Barraquer, anses pleines (Chrome) / Kratz-Barraquer Lidsperrer, Valven aus Chrom (solid)

**Length : 42 mm**  
**Width : 30 mm**  
**65° angleat base**

**SC05**



WIRE

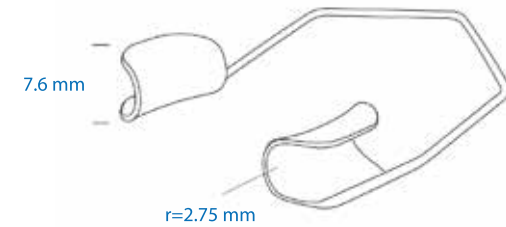

**TEMPORAL SPECULUM** / Blépharostat temporal de Kratz / Lidsperrer nach Kratz, feiner gebogener Draht temporal offen

**Length : 50 mm**  
**Width : 42 mm**

**SC12**

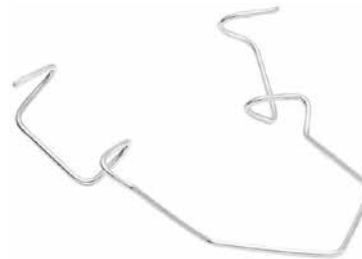

WIRE

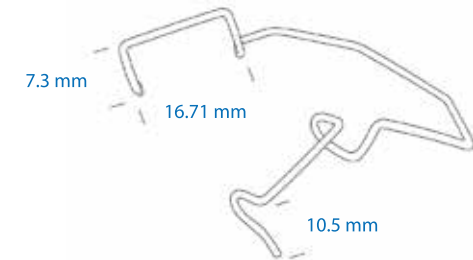

**BANGERTER ADULT SPECULUM** / Blepharostat de Bangerter / Lidsperrer für Erwachsene nach Bangerter

**Length : 50 mm**  
**sliding screw adjustable**  
**Blade length : 15 mm**

**SC03**



MECHANICAL

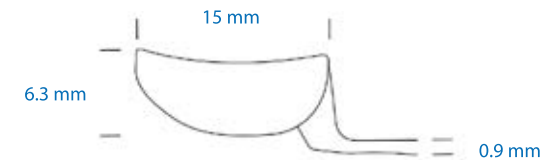

**LIEBERMAN ADJUSTABLE SPECULUM, STAINLESS STEEL** / Blépharostat Lieberman mécanique, anses fil / Mechanisches verstellbarer Lidsperrer nach Lieberman

**Overall Length : 81 mm**  
**Blade Length : (R) 14.5 mm / (L) 14.2 mm**  
**Radius of blades : 2.5 mm**  
**Thickness of wire : 0.9 mm**

**SC121**



MECHANICAL

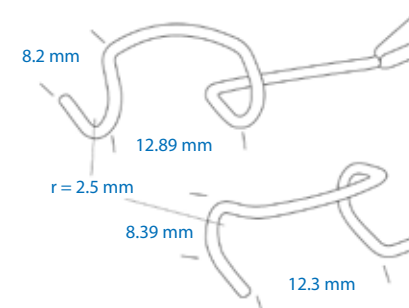

**BLADED ADJUSTABLE SPECULUM** / Blépharostat mécanique, anses pleines / Lidsperrer nach Barraquer, Valven aus Vollmaterial

**Length : 75 mm**  
**Blade length : 15 mm**

**SR10**



MECHANICAL

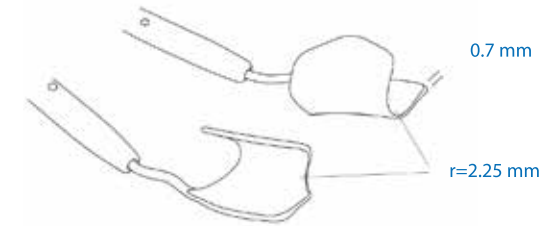

**CLARKE SPECULUM** / Blépharostat de Clarke / Clarke Lidsperrer

**Length : 80 mm**  
**Open loop : 12 mm**

**SC126**



MECHANICAL

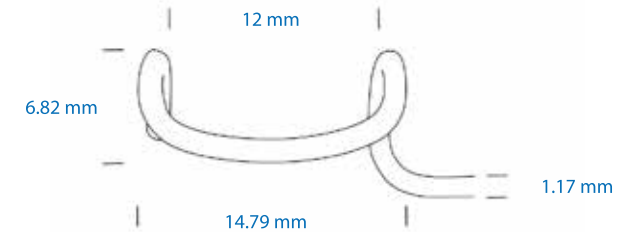

**KRATZ SCREW ADJUSTABLE WIRE SPECULUM OPEN LOOP** / Blépharostat mécanique Kratz, anses fil / mechanisches verstellbarer Lidsperrer nach Kratz (feiner gebogener Draht) temporal offen

**Length : 78 mm**  
**Blade length : 15 mm**

**SR11**



MECHANICAL

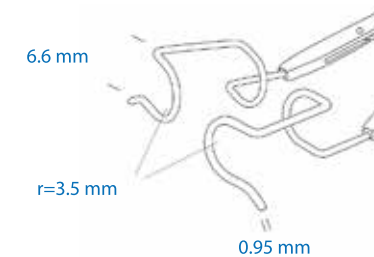

**SOLID BLADED SCREW ADJUSTABLE SPECULUM** / Blépharostat mécanique / Mechanisch feststellbarer Lidsperrer mit Valven aus Vollmaterial

**Length : 85 mm**  
**Blade length : 14 mm**

**SC08**



MECHANICAL

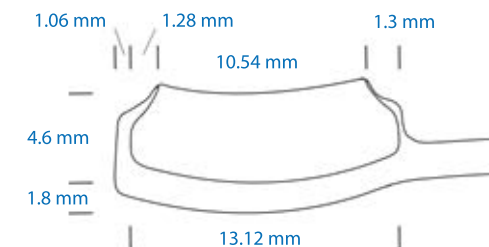

KRATZ PAEDIATRIC CLOSED LOOP 10 MM SPECULUM / Blépharostat pédiatrique de Kratz / Paediatrischer Lidsperrer nach Kratz 10mm

**Length : 29 mm**  
**Width : 30 mm**  
**10 mm closed loop**

**SC10**



PAEDIATRIC

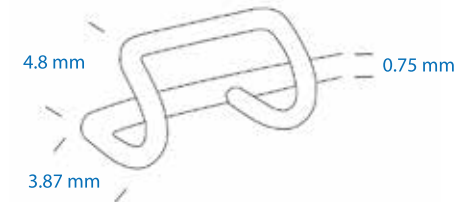

NEONATE PAEDIATRIC SPECULUM / Blépharostat néonatal Necker / Neonatal paediatrischer Lidsperrer

**Length : 25 mm**  
**Width : 20 mm**  
**4 mm closed loop**  
**80° angle at base**

**SC103**



PAEDIATRIC



NEONATE 4 MM SPECULUM / Blépharostat néonatal 4 mm / Neonatal Lidsperrer 4 mm

**Length : 25 mm**  
**Width : 31 mm**  
**20-30 mm adjustable**  
**3 mm blade**

**SC15**



PAEDIATRIC

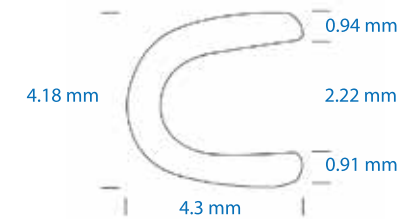

PAEDIATRIC 6 MM SPECULUM / Blépharostat pédiatrique 6mm / Paediatrischer Lidsperrer 6mm

**Length : 25 mm**  
**Width : 35 mm**  
**6 mm blade**

**SC14**



PAEDIATRIC

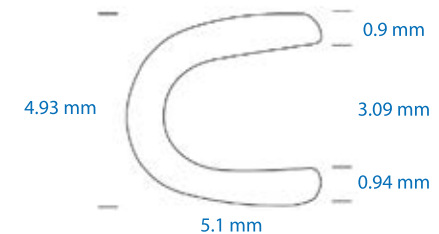

**Just Quality // Une qualité de fabrication et une éthique irréprochables.** Nos instruments sont marqués CE et fabriqués dans le respect des normes internationales en vigueur. Les process de fabrication intègrent des contrôles qualité et inspections, garants de la reproductibilité et de la qualité des instruments mis sur le marché. Nous nous efforçons d'agir de manière éthique et responsable.

## SCISSORS / Ciseaux / Scheren

 **SPRING HANDLED | SPECULUMS PAEDIATRIC**

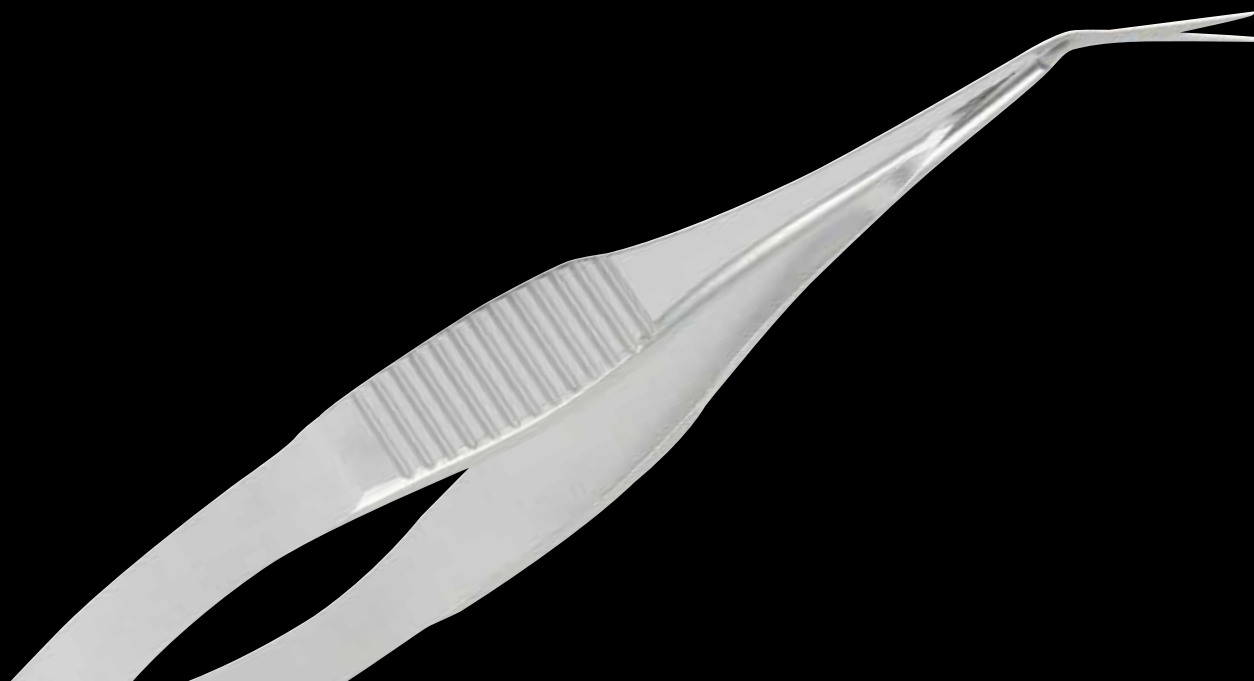

**CASTROVIEJO CORNEAL SCISSORS RIGHT AND LEFT / Ciseaux de Castroviejo droite et gauche / Castroviejo Cornea Schere rechts und links**

**Length : 100 mm**  
**Handle length : 75 mm**  
**Castroviejo corneal scissor right (SC82)**  
**Castroviejo corneal scissor left (SC83)**  
**8 mm blade**



**SC82**  
**SC83**

SPRING HANDLED

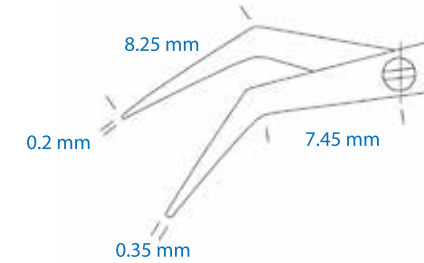

**CASTROVIEJO SCISSORS STRAIGHT & ROUND / Ciseaux de Castroviejo, courbes, mousses / Castroviejo Mikro-Schere, gebogen, stumpf**

**Length : 110 mm**  
**Handle : 65 mm**  
**11 mm blade**



**SC110**

SPRING HANDLED

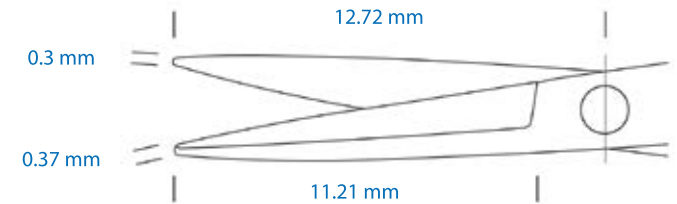

**ONG IRIS SCISSORS / Ciseaux ONG / ONG Iris Schere**

**Length : 88 mm**  
**Handle : 52 mm**  
**10 mm blade**



**SC80**

SPRING HANDLED

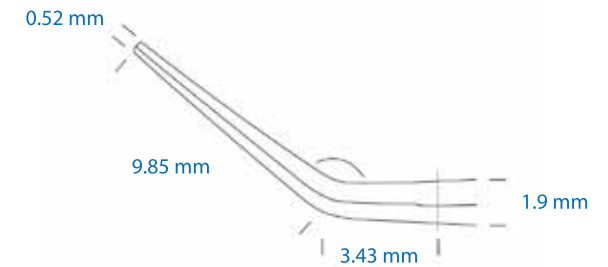

**OSHER SCISSORS / Ciseaux à implant (Osher) / Osher Schere**

**Length : 95 mm**  
**Handle length : 61 mm**  
**Fine serrated cutting platform**  
**9 mm blade**



**SC109**

SPRING HANDLED

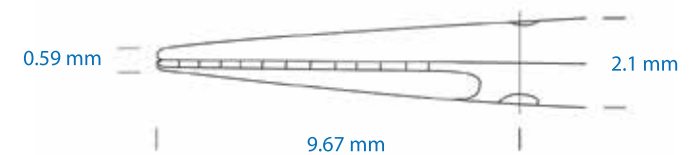



**STALLARD CORNEAL SCISSORS** / Ciseaux de Stallard / Stallard Hornhautschere

**Length : 120 mm**  
**Handle length : 67 mm**  
**Fine pointed ends**  
**40 mm blade**

**SA13**



SPRING HANDLED

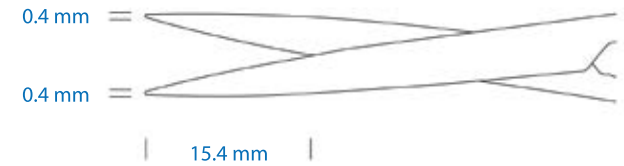

**VANNAS SCISSORS** / Ciseaux de Vannas / Vannas Schere

**Length : 83 mm**  
**Handle length : 52 mm**  
**8 mm blade**

**SC81**



SPRING HANDLED

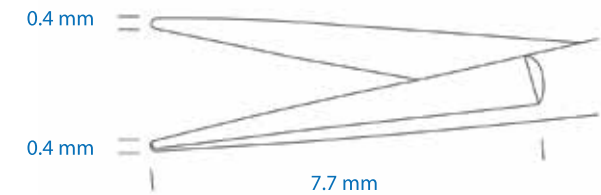

**VANNAS SCISSORS CURVED** / Ciseaux de Vannas, courbes / Vannas Schere gebogen

**Length : 100 mm**  
**Handle length : 62 mm**  
**Sharp pointed end**  
**9 mm blade**

**SC108**



SPRING HANDLED

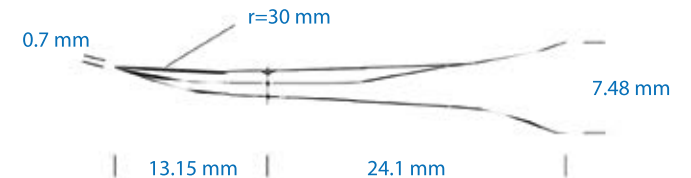

**WESTCOTT CONJUNCTIVAL SCISSORS** / Ciseaux de Westcott, courbes / Westcott Bindehautschere

**Length : 115 mm**  
**Handle length : 79 mm**  
**12 mm blade**

**SA11**



SPRING HANDLED



WESCOTT SCISSORS DOLPHIN NOSE / Ciseaux de Wescott, extrémités émoussées (en forme de dauphin) / Westcott Schere, stumpfe Enden (delphinförmig)

Length : 115 mm  
 Handle length : 67 mm  
 10 mm blade



SA14

SPRING HANDLED

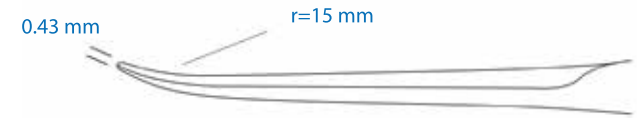

CASTROVIEJO SCISSORS STRAIGHT / Ciseaux de Castroviejo, droits / Castroviejo Schere, gerade

Length : 100 mm  
 Handle length : 63 mm  
 Straight tipped  
 60 mm blade



SC111

SPRING HANDLED

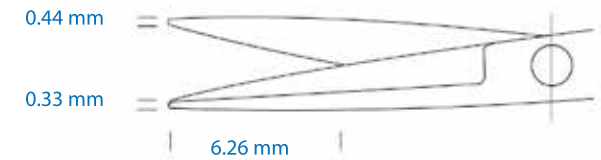

DRESSING SCISSORS / Ciseaux à disséquer, extrémités courbes et mousses / Verbandsschere gebogen mit abgerundete Spitze

Length : 115 mm  
 Handle length : 26 mm  
 30 mm blade



SG35

GENERAL



ENUCLEATION SCISSORS / Ciseaux à énucléation / Enukleationsschere

Length : 25 mm  
 6 mm blade



SG34

GENERAL



**GENERAL SCISSORS LONG BLUNT ENDS** / Ciseaux à disséquer, droits, mousses / Augenschere lang gerade, stumpfe Enden

**Length : 130 mm**  
**Blunt round end**  
**40 mm blade**

**SG14**



GENERAL

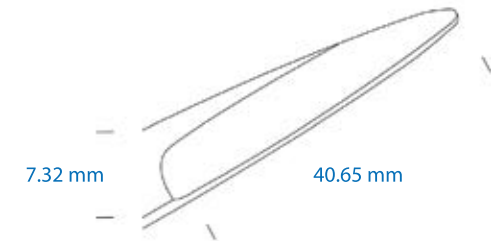

**GENERAL SCISSORS BLUNT END** / Ciseaux courts, pointes droites, bout mousse / Augenschere, stumpfe Enden

**Length : 89 mm**  
**Blunt end**  
**24 mm blade**

**SG06**

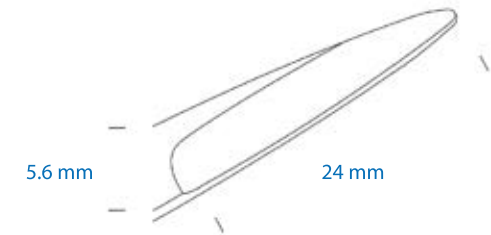

GENERAL

**GENERAL SCISSORS SHARP POINTED** / Ciseaux courts pointus / Augenschere, spitze Enden

**Length : 88 mm**  
**Sharp pointed end**  
**22 mm blade**

**SG01**



GENERAL



**METZENBAUM SCISSORS CURVED POINTED** / Ciseaux de Metzenbaum, courbes, pointus / Metzbaum Schere, gebogen, spitz

**Length : 110 mm**  
**35 mm blade**

**SG30**

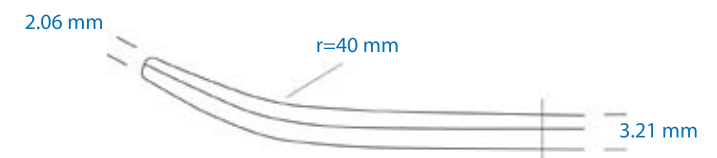

GENERAL



**STRABISMUS SCISSORS** / Ciseaux à strabisme / Strabismus Schere

**Length : 115 mm**  
**Blunt end**  
**38 mm blade**

**SG07**



SPRING HANDLED



**STEVENS SCISSORS CURVED** / Ciseaux de Stevens courbes / Schere nach Stevens, gebogen

**Length : 115 mm**  
**38 mm blade**  
**30 mm tip**

**SG23**



SPRING HANDLED

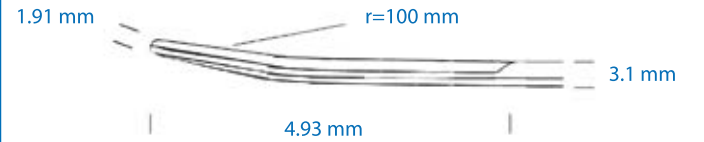

**IRIS SCISSORS** / Ciseaux à iris, ciseaux à disséquer, droits, pointus / Iris Schere, gebogen

**Sharp, pointed end**  
**Overall length : 109 mm**  
**Blade length : 22 mm**  
**Tip width : 0.7 mm**

**SC96**



SPRING HANDLED

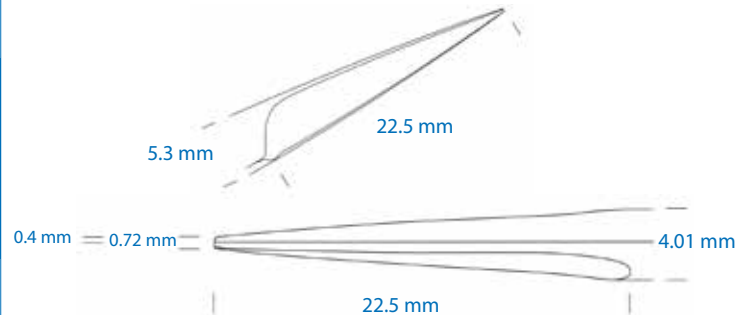

**Just Quality // Qualität der Herstellung und einwandfreie Ethik.**

Unsere Instrumente sind CE-gekennzeichnet und werden in Übereinstimmung mit den aktuellen internationalen Standards hergestellt. Zu den Fertigungsprozessen gehören Qualitätskontrollen und Prüfungen, die Reproduzierbarkeit und die Qualität der auf den Markt gebrachten Geräte garantieren. Wir bemühen uns, ethisch und verantwortungsvoll zu handeln.

# MEASURERS & MARKERS

Mesureurs & Marqueurs

Messinstrumente & Marker



**BRAUNSTEIN FIXED CALIPER 1.8 MM THICKNESS** / Marqueur de Braunstein, métal / Braunstein Kaliber fix 1.8 mm Dicke

**Length : 68 mm**  
**Thickness : 1.8 mm**  
**Handle length : 61 mm**

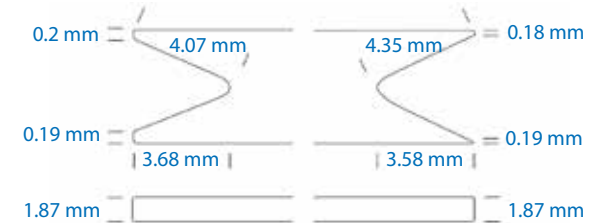

**CASTROVIEJO ADJUSTABLE CALIPER** / Compas de Castroviejo, pointes droites / Castoviejo verstellbarer Zirkel

**Length : 85 mm**  
**Width : 43 mm**  
**20 mm measure**

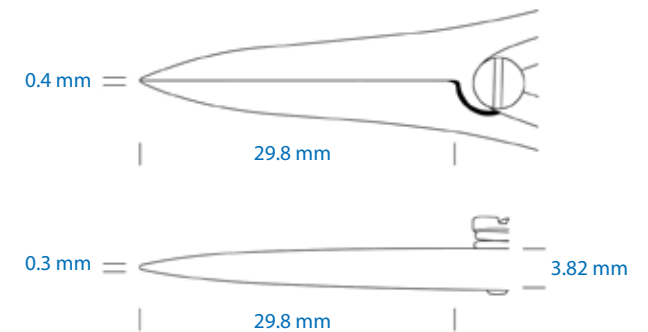

**HELVESTON RULER** / Règle d'Helveston / Helveston Meßspatel

**Overall Length : 118 mm**  
**Handle Length : 89 mm**

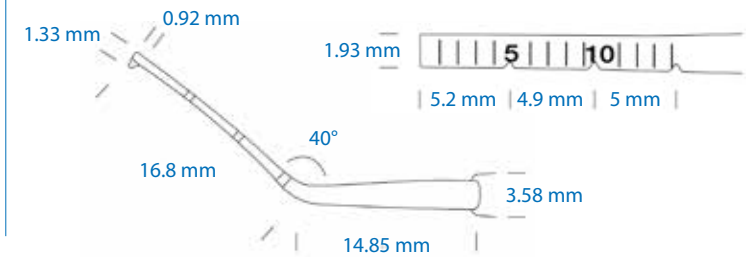
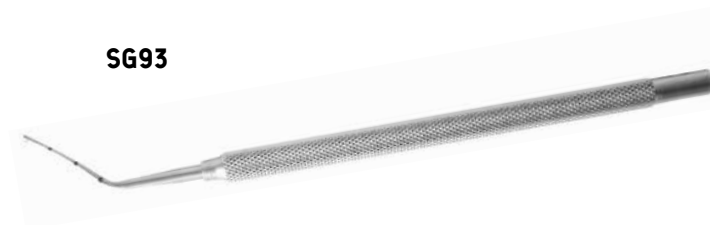

**MENDEZ GAUGE** / Anneau de Mendez / Messlehre nach Mendez (zur Bestimmung des Einschnittwinkels)

**Length : 120 mm**  
**Handle length : 80 mm**  
**180° circular marker**

**SC65**

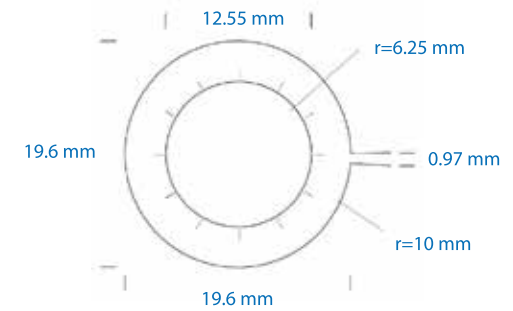

**SCLERAL MARKER ROUND BODIED DOUBLE ENDED** / Marqueur scléral métal 3.5 mm - 4.5 mm / Skleral Marker runder Griff, zweiseitig

**4.5 mm and 3.5 mm marking ends**  
**Length : 110 mm**  
**Handle : 60 mm**  
**Round bodied**  
**Double ended**

**SG19**

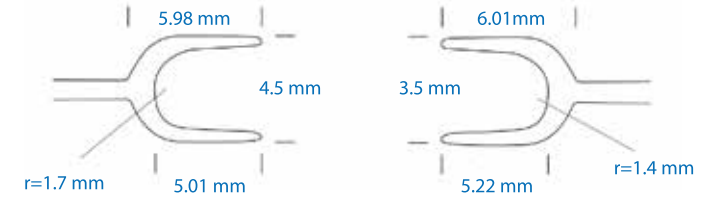

**8 LINE CORNEAL MARKER** / Marqueur cornéen 8 branches / Sternförmiger Kornea Marker mit 8 Linien

**Overall Length : 109 mm**  
**Handle length : 81 mm**

**SR72**

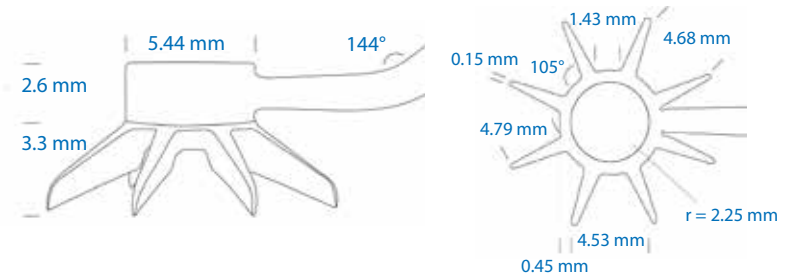

**Just Innovation // Continuous improvement and innovation are our driving force.**

Our research and development team is constantly monitoring the market in order to offer surgical instruments in line with expressed needs. Our know-how is at the disposal of the users for any request for development of new or custom made instruments.

# CURETTES & CLAMPS

Curettes & Pincers  
Küretten & Klemmen



## CHALAZION CLAMP MEDIUM

Pince à chalazion medium  
Chalazion Klemme Medium

**Overall Length : 90mm**  
**Handle Length : 54 mm**  
**21 mm diameter oval plate**

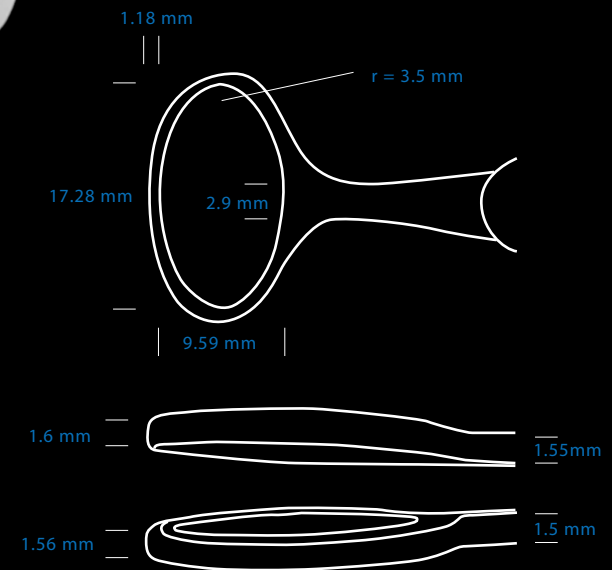



**CURETTE VARIOUS SIZES** / Currettes à chalazion / Küretten verschieden Größen

**Length : 110 mm**  
**Handle length : 80 mm**  
**CR01 Curette small**  
**CR02 Curette medium,**  
**(2.5 mm diameter chalazion curette)**  
**CR03 Curette large,**  
**(4 mm oval shaped chalazion curette)**

**CR01**  
**CR02**  
**CR03**



CURETTES

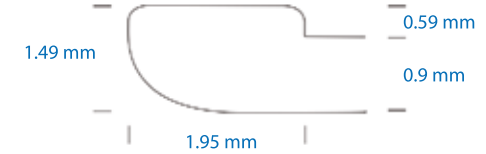

**CURETTE DOUBLE ENDED** / Curette double / Kürette zweiseitig

**Length : 130 mm**  
**Handle length : 65 mm**  
**Chalazion curette 2.5 mm diameter end**  
**and oval end**

**CR05**



CURETTES

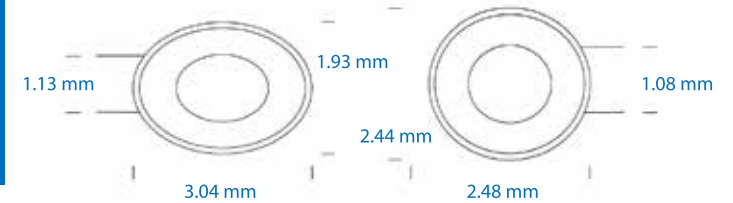

**CHALAZION CLAMP SMALL** / Pince à chalazion 12 mm / Chalazion Klemme klein

**Length : 115 mm**  
**Handle length : 82 mm**  
**12 mm diameter plate**

**CS01**



CLAMPS

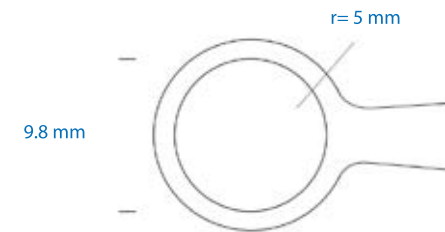

**CHALAZION CLAMP LARGE** / Pince à chalazion large, ovale / Chalazion Klemme groß

**Length : 85 mm**  
**Handle length : 53 mm**  
**21 mm diameter oval plate**

**CS02**



CLAMPS

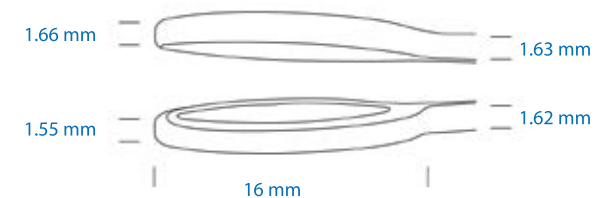

**Just Innovation // L'amélioration continue et l'innovation sont nos moteurs.**

Notre équipe de recherche et développement est constamment à l'écoute du marché, afin de proposer des instruments chirurgicaux en adéquation avec les besoins exprimés. Notre savoir-faire est à la disposition des utilisateurs pour toute demande de développement d'instruments nouveaux ou sur-mesure.

# NEEDLE HOLDERS

Porte-Aiguilles

Nadelhalter



SC61

## SUTURE NEEDLE HOLDER CURVED

Porte-aiguille, mors courbes

Nähnelhalter, gebogen

**Length : 135 mm**

**Handle length : 86 mm**

**6 mm jaw**

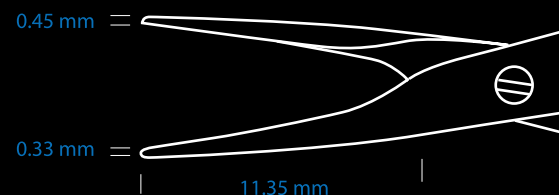

**BARRAQUER NEEDLE HOLDER CURVED** / Porte-Aiguille de Barraquer, courbe / Barraquer Nadelhalter gebogen

**Length : 115 mm**  
**Handle length : 82 mm**  
**12 mm diameter plate**  
**Round bodied**

**SC142**

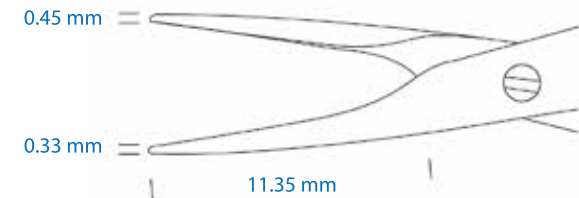

**CASTROVIEJO NEEDLE HOLDER LOCKING** / Porte-aiguille de Castroviejo droit, verrou / Castroviejo Nadelhalter mit Sperre

**Length : 140 mm**  
**Handle length : 82 mm**  
**Straight tips 20.7 mm**  
**Flat handle**

**SC118**

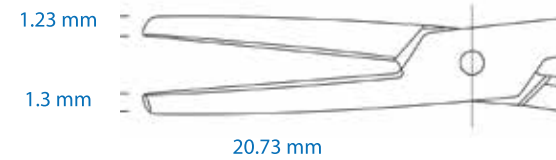

**NEEDLE HOLDER BLUNT LOCK** / Porte-aiguille, bout mousse, verrou / Nadelhalter stumpf, mit Sperre

**Length : 135 mm**  
**Handle length : 82 mm**

**SC62**

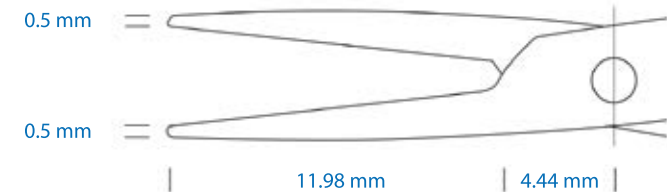

**NEEDLE HOLDER CURVED** / Porte-aiguille, courbe / Nadelhalter, gebogen

**Length : 100 mm**  
**Handle length : 75 mm**

**SC114**

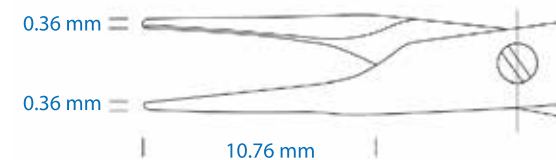

**Just Innovation // Unser Bestreben sind kontinuierliche Verbesserung und Innovationen.**

Unser Forschungs und Entwicklungsteam hat ständig ein offenes Ohr am Markt, um chirurgische Instrumente entsprechend den Anforderungen anzubieten. Unser Know-how steht den Benutzern für jede Anfrage zur Entwicklung neuer oder maßgeschneiderter Instrumente zur Verfügung.

# LACRIMAL

Lacrymal

Lakrimal

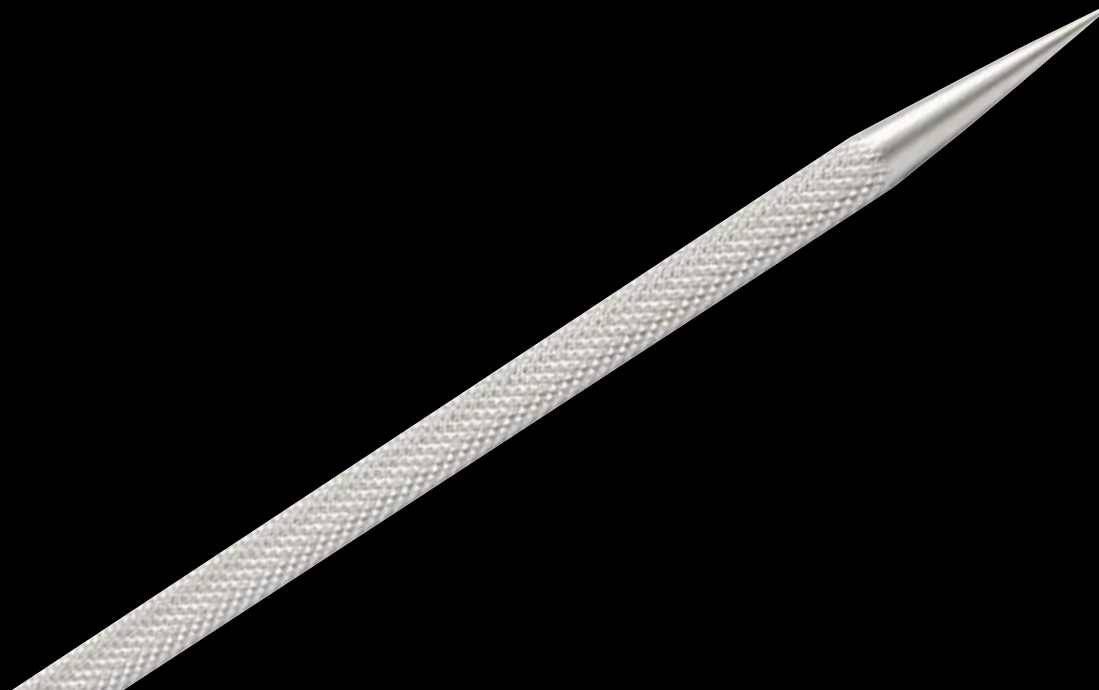

**BOWMANS PROBE SIZE 00-0 DOUBLE ENDED** / Sonde de Bowman double 00-0 / Tränenwegsonde Bowman Größe 00-0 zweiseitig

**Length : 50 mm**  
**Handle length : 30 mm**

**PD05**

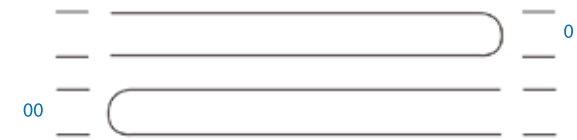

**BOWMANS PROBE SIZE 000-00 DOUBLE ENDED** / Sonde de Bowman double 000-00 / Tränenwegsonde Bowman Größe 000-00 zweiseitig

**Length : 50 mm**  
**Handle length : 30 mm**

**PD06**

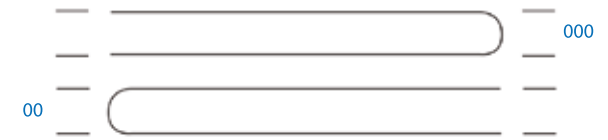

**LACRIMAL PROBE** / Sonde à voies lacrymales / Lakrimal Sonde

**Length : 95 mm**  
**Handle length : 15 mm**  
**0.5 mm pointed end**

**PD08**



**PUNCTAL DILATOR BLUNT** / Dilatateur voies lacrymales, mousse / Tränenwegsonde stumpf

**Length : 95 mm**  
**Handle length : 80 mm**  
**0.4 mm pointed sharp end**  
**Round bodied**

**PD02**

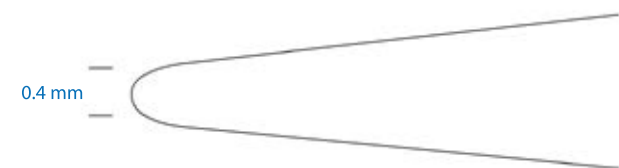

**PUNCTAL DILATOR DOUBLE ENDED** / Dilateur voies lacrymales, fin-medium / Tränenwegsonde zweiseitig

**Length : 115 mm**  
**Handle length : 85 mm**  
**0.4 and 0.3 mm sharp pointed ends**  
**Round bodied**

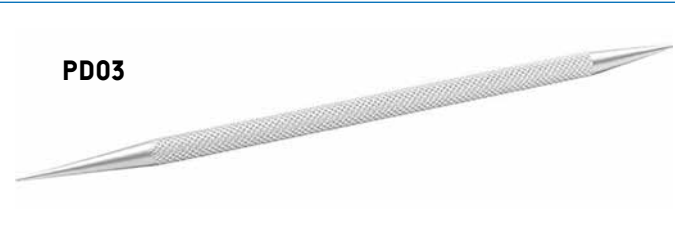

**PD03**

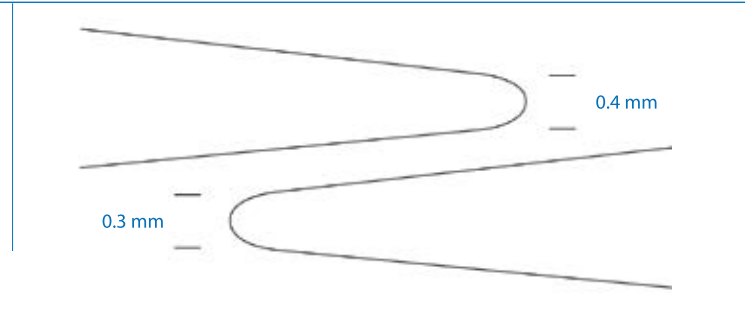

**PUNCTAL DILATOR SHARP** / Dilateur voies lacrymales, très fin / Tränenwegsonde scharf

**Length : 95 mm**  
**Handle length : 78 mm**  
**0.2 mm pointed sharp end**  
**Round bodied**

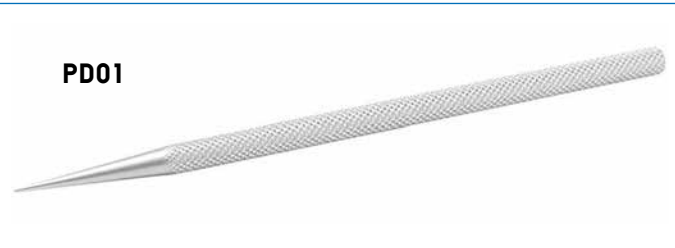

**PD01**

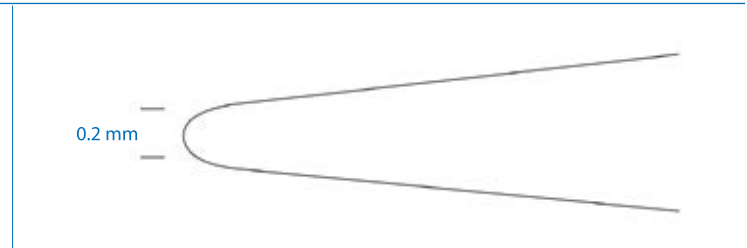

**PUNCTAL DILATOR SHORT** / Dilateur voies lacrymales, manche court / Tränenwegsonde kurz

**Length : 50 mm**  
**Handle length : 30 mm**  
**0.3 mm sharp pointed ends**  
**Round bodied**



**PD04**

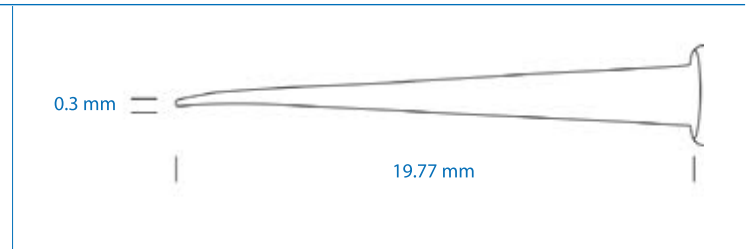

**PUNCTAL DILATOR & LACRIMAL PROBE DOUBLE ENDED** / Dilateur-Sonde pour voies lacrymales / Tränenwegsonde zweiseitig

**Length : 140 mm**  
**Handle length : 70 mm**  
**Curved and pointed end**



**PD07**

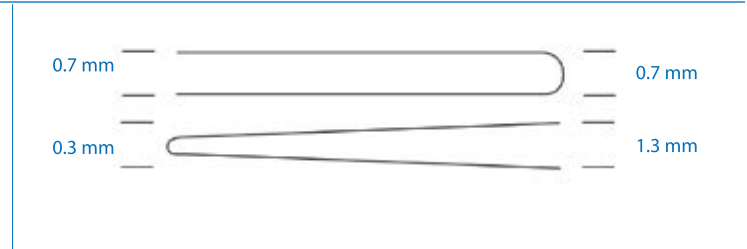

# CORNEAL & REFRACTIVE

Cornée & Réfractive  
Korneal & Refraktiv

## LASIK FLAP-LIFTING FORCEPS

Pince angulée mors long  
Lasik Flap Hebepinzette

Overall length : 103 mm  
Handle length : 78 mm  
11 mm platform

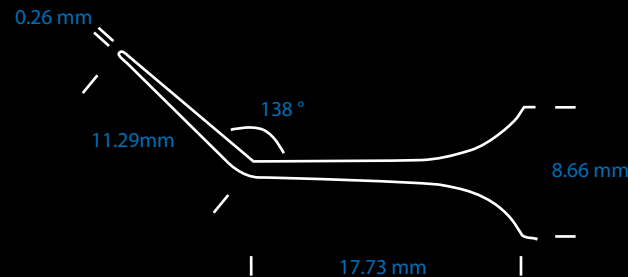

## REINSTEIN LENTICULE SEPARATOR

Séparateur Relex  
Relex Häkchen

Length : 110 mm  
Handle length : 90 mm  
90° angled

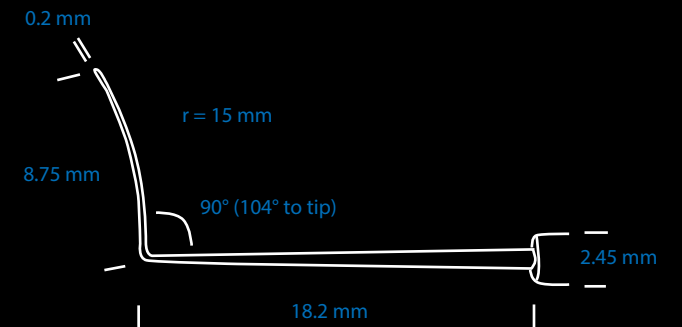
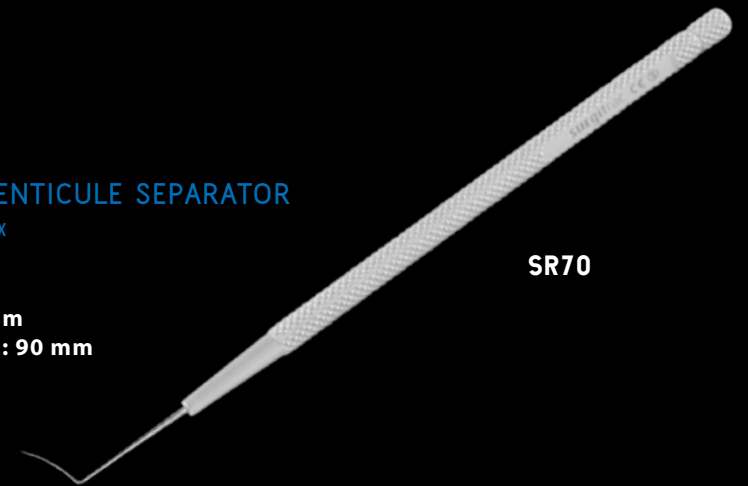

**DMEK BERNHEIM HOOK** / Crochet DMEK de Bernheim / DMEK Häkchen nach Bernheim

**Length : 120 mm**  
**Handle length : 95 mm**

**SR109**



**CORNEAL EPITHELIUM SPATULA ROUND** / Spatule pour épithélium cornéen, ronde / Epithelium Hornhautspatel, rund

**Length : 110 mm**  
**Handle length : 85 mm**

**SR100**



**CK LASIK MARKER** / Marqueur LASIK avec croix de centrage / Hornhautmarker mit Fadenkreuz

**Length : 100 mm**  
**Handle length : 76 mm**  
**Facilitate marking of the cornea**  
**Round bodied**

**SR40**

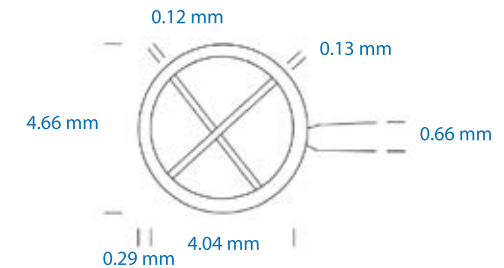

**EPI PEELER** / Scarificateur cornéen / Epi Peeler

**Length : 110 mm**  
**Handle length : 95 mm**  
**Manipulate epithelium during surgery**

**SR51**

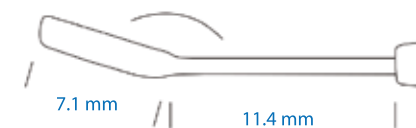



## EPI PEELER RECTANGLE SHAPED / Scarificateur, forme D / Epi Peeler - quadratische Form (LASIK)

**Length : 110 mm**  
**Handle length : 95 mm**

SR61



## EPI PEELER D SHAPED / Scarificateur Micro-Houe / Epi Peeler, gebogen

**Length : 110 mm**  
**Handle length : 95 mm**

SR60

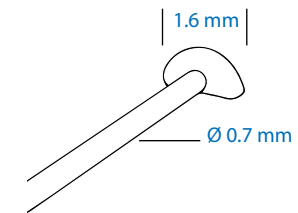

## INTRA LASIK FLAP SEPARATOR / Elévateur volet cornéen, crochet pointu / Intra-Lasik Flap Separator

**Length : 120 mm**  
**Round bodied**

SR34

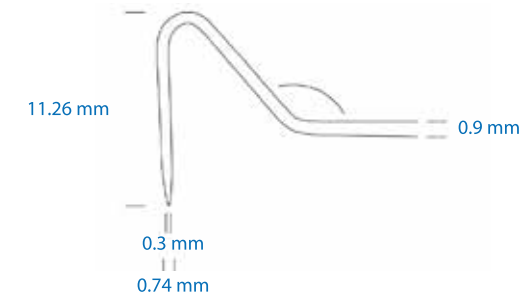

## KOCABA DMEK FORCEPS / Pince DMEK de Kocaba / Kocaba DMEK Pinzette

**Length : 86 mm**  
**Handle length : 56 mm**

SR102

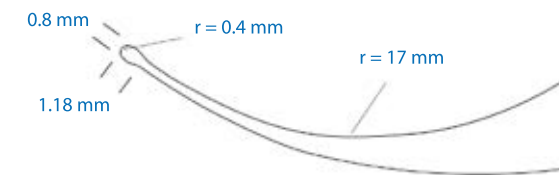

ALCOHOL WELL VARIOUS SIZES / Anneau marqueur / Lasek Alkohol Trichter

Length : 125 mm  
 Handle length : 92 mm  
 Liquid holding well for alcohol application  
 Round bodied  
 SR41 9 mm  
 SR42 8 mm  
 SR43 7 mm

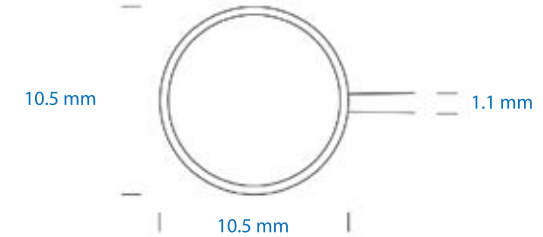

LASIK CORNEAL MARKER / Marqueur cornéen en fourche / Lasik Hornhautmarker

Length : 120 mm  
 Handle length : 91 mm  
 Y shaped forked marker

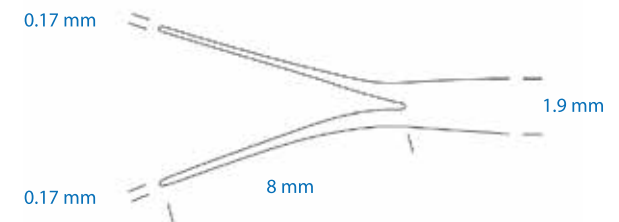

LASIK FLAP ELEVATOR / Spatule Flap Lasik / LASIK Flap Heber

Length : 120 mm  
 Handle length : 95 mm  
 45° angled, 12 mm tip with 0.1 mm rounded end

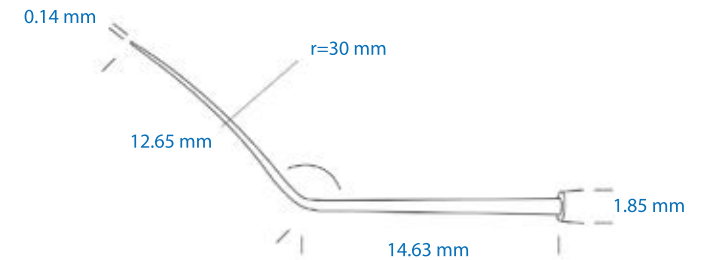

LASIK FLAP FORCEPS / Pince Flap Lasik / Lasik Flap Pinzette

Length : 100 mm  
 Handle length : 77 mm  
 40° angled platform, circular 1 mm tips

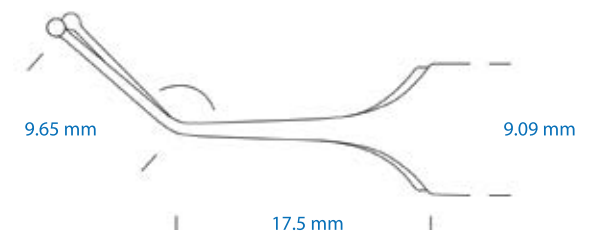

## LASIK FLAP SEPERATOR AND ELEVATOR DOUBLE END / Séparateur-élévateur LASIK, droit / Flap Heber gerade

**Length : 120 mm**  
**Handle length : 70 mm**  
**45° and 65° ends**  
**Double ended**

SR103

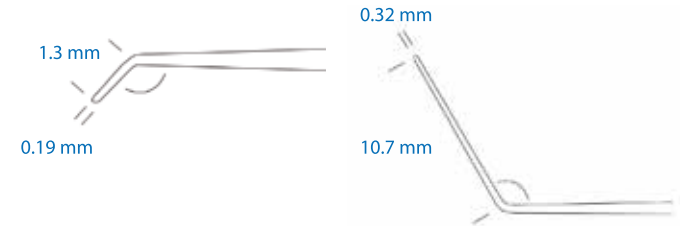

## LENTICULE SEPERATOR HOOK AND SPATULA DOUBLE END / Relex Crochet / Séparateur, Spatule / Relex Häkchen / Separator (Kombi-Instrument)

**Length : 110 mm**  
**Handle length : 70 mm**  
**75° ends**  
**Double ended**

SR104

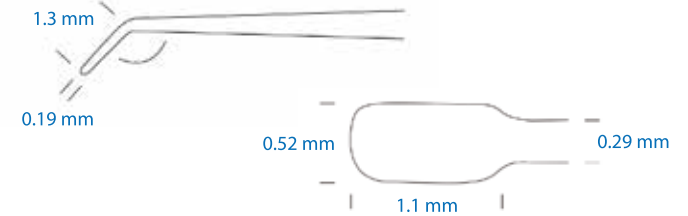

## S MARKER / Marqueur DMEK «S» / S Marker

**Length : 110 mm**  
**Handle length : 90 mm**  
**45° angle 2 mm marking end**

SR101

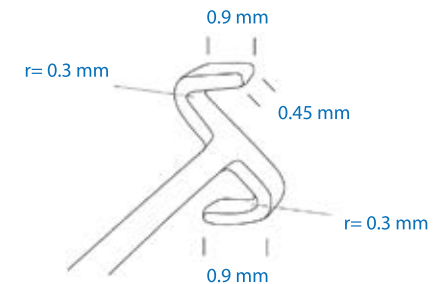

## TREPINE VARIOUS SIZES / Trépan cornéen / Trepane verschiedene Größen

**SR105 17 mm**  
**SR106 18 mm**  
**SR107 19 mm**  
**SR110 16 mm**

SR105

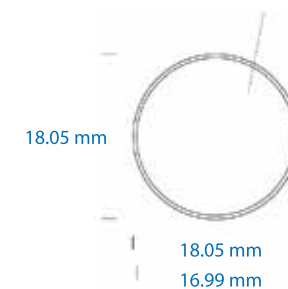

LASIK FEMTO SEPARATOR AND ELEVATOR DOUBLE ENDED / Séparateur-Élévateur Siebel / Lasik Femto Separator und Elevator zweiseitig

**Length : 115 mm**  
**Handle length : 70.3 mm**  
**Round bodied**  
**Double ended**

**SR02**

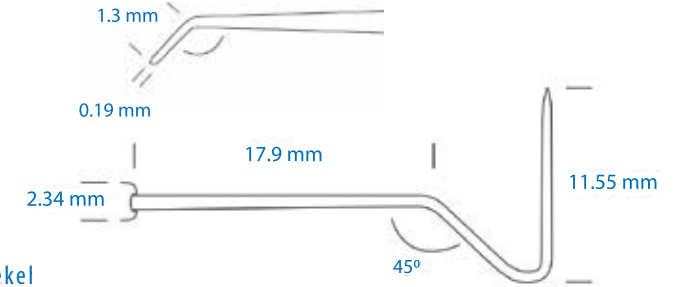

SINSKEY AND REVERSE SINSKEY HOOK / Manipulateur double Sinskey-Sinskey inversé / Sinskey Håkchen umgekel

**Length : 120 mm**  
**Handle length : 70.3 mm**  
**Round bodied**  
**Double ended**

**SR03**

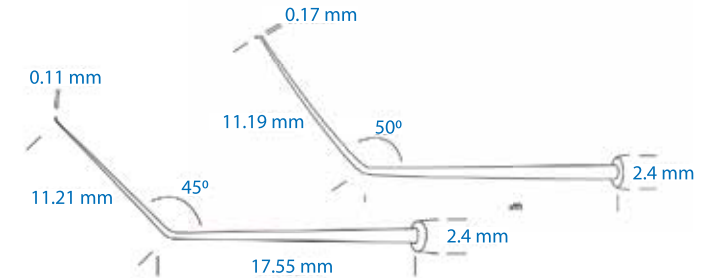

CORNEAL RING PUSHER / Manipulateur anneau intra-cornéen / Manipulator für Cornealen Ring

**Length : 110 mm**  
**Handle length : 91 mm**  
**Round bodied**

**SR04**



CORNEAL RING POCKETING HOOK / Crochet anneau intra-cornéen / Taschen Haken für Cornalen Ring

**Length : 111 mm**  
**Handle length : 91 mm**  
**Round bodied**

**SR05**



## CORNEAL RING POCKET SPREADER / Spatule anneau intra-cornéen / Taschen Spreizer für Cornealen Ring

**Overall Length : 108 mm**  
**Handle Length : 90 mm**

SR06

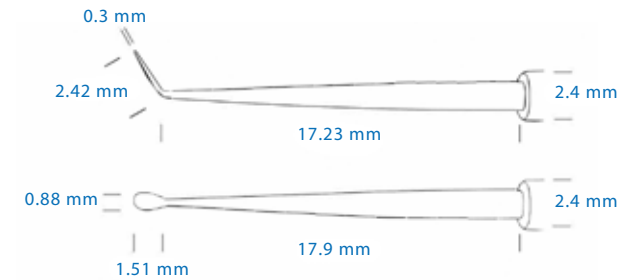

## CORNEAL RING FORCEPS KERARING / Pince à anneau intra-cornéen - Keraring / Keraring Pinzette für Cornealen Ring

**Overall Length : 103 mm**  
**Handle Length : 77 mm**

SR07

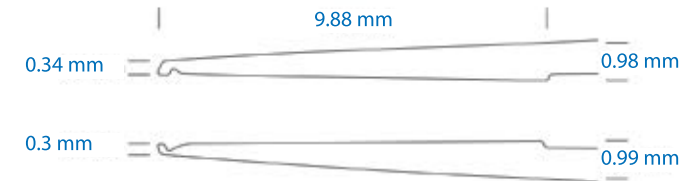

## CORNEAL RING FORCEPS INTACS / Pince à anneau intra-cornéen - INTACS / Intacs Pinzette für Cornealen Ring

**Length : 81 mm**  
**Handle length : 53 mm**

SR08

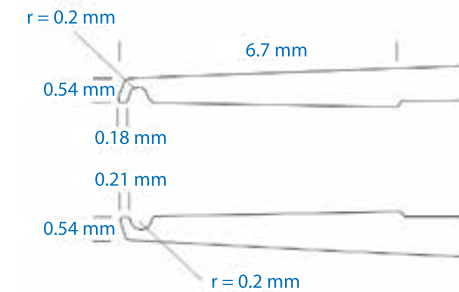

## PATON SPATULA &amp; SPOON DOUBLE ENDED / Spatule double de Paton / Paton Spatel und Löffel Zweiseitig

**Length : 151 mm**  
**Handle length : 71 mm**  
**Round bodied**  
**Double ended**

SR108

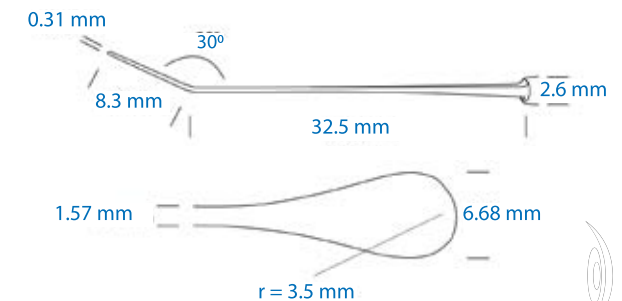

LENTICULE EXTRACTION FORCEPS / Pince à extraction de lenticule / Lentikel Extraktion Pinzette

**Overall Length : 115 mm**  
**Handle Length : 81 mm**



SR01

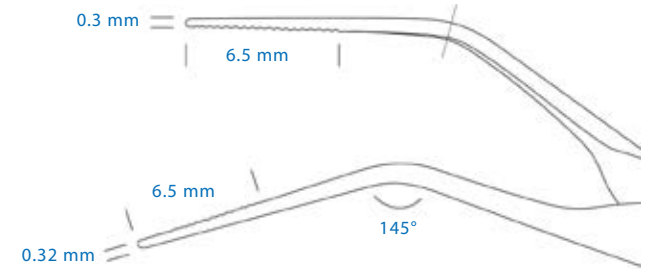

CORNEAL MARKER CAPSULORHEXIS GUIDE / Marqueur cornéen 6mm / Hornhautmarker für Kapsulhorexis

**Length : 120 mm**  
**Handle length : 92 mm**  
**6 mm well**  
**Round bodied**



SC130

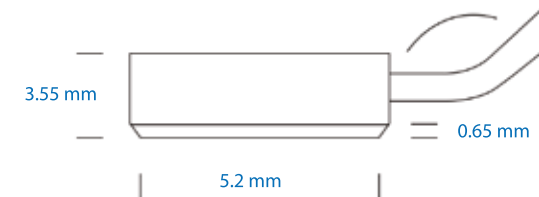

# GENERAL OPHTHALMIC

Ophtalmologie Générale  
 Allgemeine Ophthalmologie



SG12

THORNTON FIXATION RING SMALL 13 MM

Anneau de fixation de Thornton 13 mm  
 Thornton Fixationsring klein 13 mm

**Length : 130 mm**  
**Handle length : 91 mm**  
**Swivel head 11 mm cut outer oval plate**

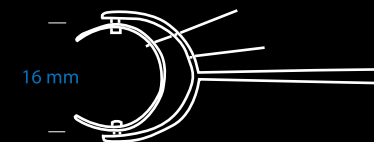

**BALL TIP MUSCLE HOOK / Crochet à muscle, point boule / Schielhäkchen, ballförmige Spitze**

**Length : 105 mm**  
**Handle length : 76 mm**

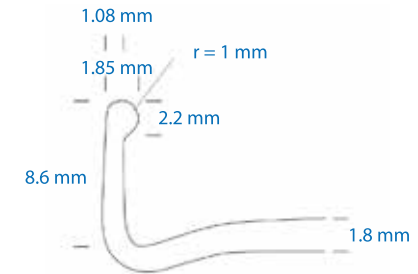

**BULLDOG CLIP / Bulldog Clip / Bulldog Clip**

**Length : 40 mm**  
**Handle length : 25 mm**  
**16 mm clipping platform**

**SG92**

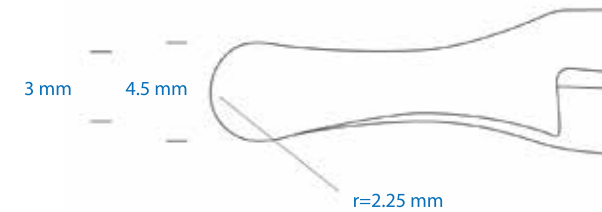

**CHAVASSE HOOK / Crochet de Chavasse / Chavasse Häkchen**

**Length : 130 mm**  
**Handle length : 98 mm**  
**90° angle, curved hooked tip**

**SC91**

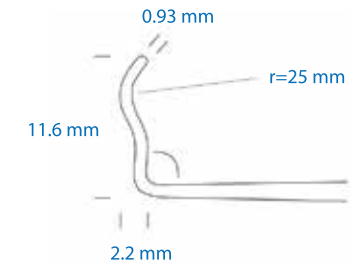

**DESMARRES RETRACTOR / Rétracteur de Desmarres / Desmarres Retraktor**

**Length : 140 mm**  
**Handle length : 100 mm**

**SG20**

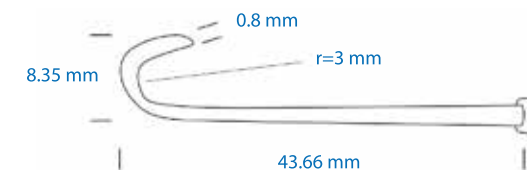

EYELID PLATE / Plaque à paupière de Jaeger / Lidplatte

Length : 90 mm  
27 mm end  
17 mm end

SG17

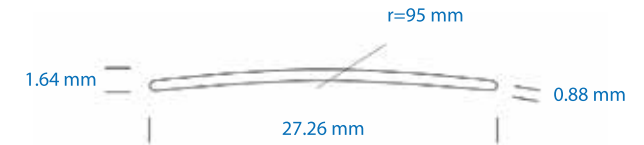

GUTHRIE HOOK / Crochet de Guthrie / Guthrie Häkchen

Length : 120 mm  
Handle length: 90 mm  
Two pronged hook

SG37

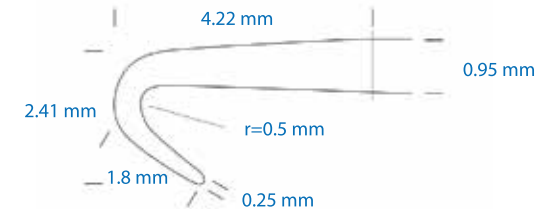

HALSTEAD MOSQUITO FORCEPS STRAIGHT / Pince de Halstead, droite / Halstead Arterienklemme, gerade

Length : 125 mm

SG33



JAMESON STRABISMUS HOOK 5 MM / Crochet à strabisme de Jameson / Jameson Schielhaken

Length : 110 mm  
Handle length : 83 mm  
60° hook with rounded bulbous tip  
Extended version 8 mm hook

SG10

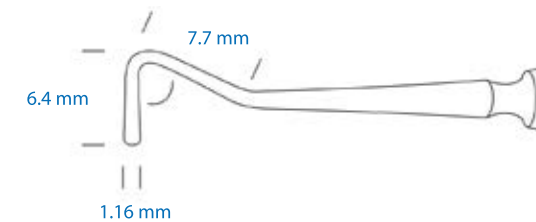



**MOSQUITO FORCEPS CURVED** / Pince Mosquito, courbe / Mosquito Pinzette, gebogen

**Length : 125 mm**  
**22 mm serrated clamp area**

**SG22**

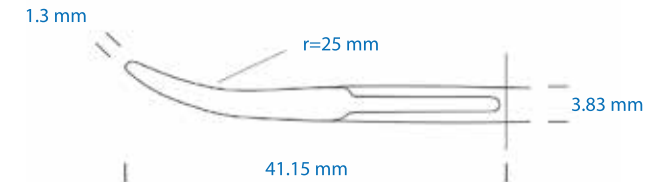

**SCLERAL DEPRESSOR BULBOUS END** / Dépresseur scléral / Skleral Depressor wulstige Enden

**Length : 130 mm**  
**Handle length : 92 mm**  
**2.5 mm 10° angled bulbous end**

**SC23**



**SCLERAL DEPRESSOR DOUBLE ENDED** / Dépresseur scléral double de Schocket / Skleral Depressor zweiseitig

**Length : 135 mm**  
**Handle length : 60 mm**  
**6 mm, 2 mm hammer end,**  
**2.5 mm 10° angled bulbous end**  
**Double ended**

**SC25**

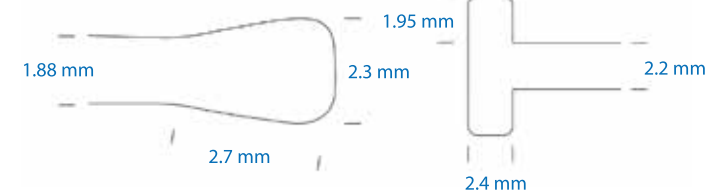

**SCLERAL DEPRESSOR HAMMER END** / Dépresseur scléral courbe / Skleral Depressor hammerförmiges Ende

**Length : 125 mm**  
**Handle length : 92 mm**  
**6 mm hammer, 2 mm ends**

**SC24**

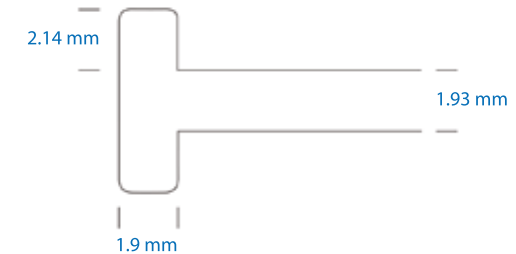

THORNTON FIXATION RING STANDARD 16 MM / Anneau de fixation de Thornton 16mm / Thornton Fixationsring standard 16 mm

**Length : 135 mm**  
**Handle length : 91 mm**  
**swivel head 14 mm cut out**



**SG13**

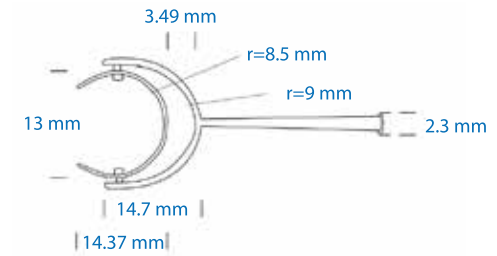

TRABECULECTOMY PUNCH / Punch à trabéculéctomie / Trabekulotomie Stanze

**Length : 120 mm**  
**Handle length : 90 mm**



**SG03**

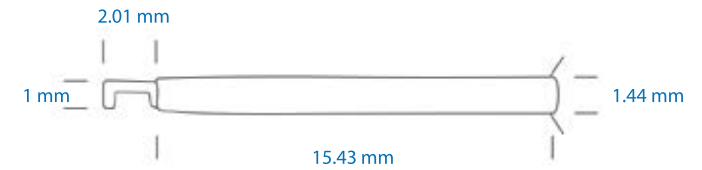

GILLIS HOOK / Crochet de Gillis / Gillis Haken

**Overall length : 123 mm**  
**Handle length : 90 mm**



**SG28**

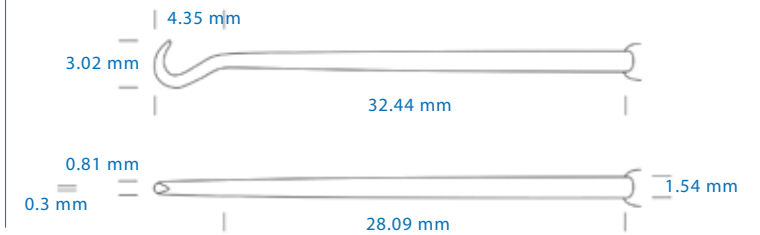

JAMESON HOOK / Crochet de Jameson, long / Jameson Haken

**Overall length : 109 mm**  
**Handle length : 83 mm**



**SG11**

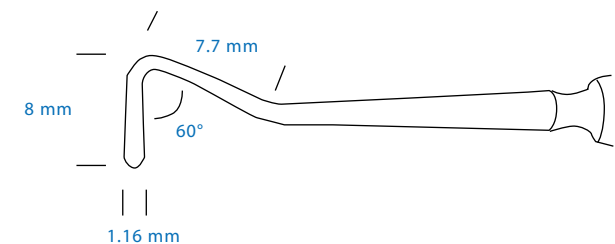



# **TRAN CANULA**

Canule de Tran

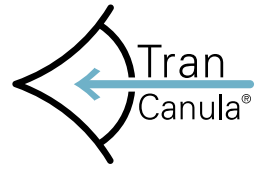

fabrinal  
EYE CARE

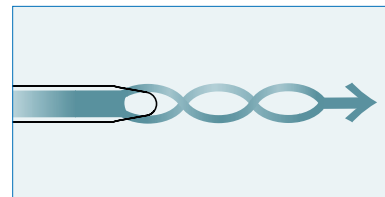
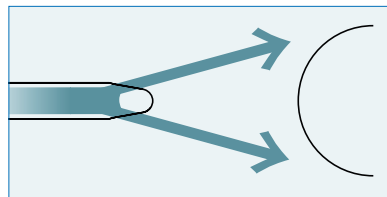
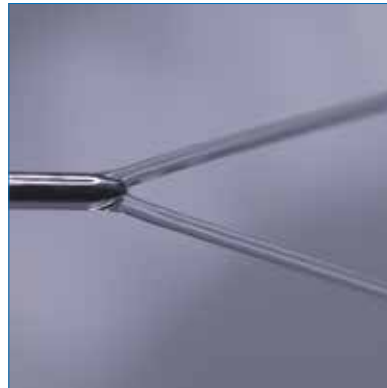

The Tran Canula® is a sterile and single use irrigation cannula used by physician in controlled environment to clear the pseudo-exfoliative particles in the anterior chamber of the eye. Unlike a conventional single jet irrigation cannula, this new instrument is characterized by two distinct water jets separated from each other by a 30° angle. Thanks to the unique design of the cannula and the laws of micro-hydrodynamics, these two independent fluid streams merge into one, more powerful, since they touch an obstacle.

#### TRAN CANULA®, TC- 01, SPECIFICATIONS

- Reference : TC- 01
- Cannula length : 19 mm
- Radius of curvature : 25 mm
- Outside diameter : 0.8 mm
- Design : Dr. V.T. Tran

#### TRAN CANULA® PACKAGING

- In a double sterile blister pack ; single use only.
- Packaging : 5 pieces
- 205 x 57 x 45 mm

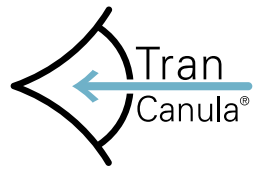

La Tran Canula® est une canule d'irrigation stérile à usage unique utilisée par le médecin dans un environnement contrôlé, pour éliminer les particules pseudo-exfoliatives déposées dans la chambre antérieure de l'œil. Contrairement à une simple canule d'irrigation à jet classique, ce nouvel instrument est caractérisé par deux jets d'eau distincts séparés l'un de l'autre par un angle de 30°. Grâce à sa conception unique et aux lois de la micro-hydrodynamique des fluides, ces deux jets indépendants fusionnent en un seul fuseau liquide, plus puissant, dès lors qu'ils touchent un obstacle.

#### TRAN CANULA®, TC- 01, SPÉCIFICATIONS

- Référence : TC- 01
- Longueur canule : 19 mm
- Rayon de courbure : 25 mm
- Diamètre extérieur : 0.8 mm
- Design : Dr. V.T. Tran

#### TRAN CANULA® PACKAGING

- Sous double blister stérile, à usage unique.
- Emballage : 5 pièces
- 205 x 57 x 45 mm

Tran Canula® ist eine sterile Einweg-Spülkanüle, die in kontrollierter Umgebung von Ärzten angewandt wird, um die pseudoexfoliativen Partikel aus der vorderen Augenkammer zu entfernen.

Im Gegensatz zur herkömmlichen Einzelstrahl-Spülkanüle zeichnet sich dieses neue Instrument durch zwei getrennte Wasserstrahlen aus, die zueinander in einem Winkel von 30° stehen. Dank des einzigartigen Designs der Kanüle und aufgrund der Gesetze der Mikrohydrodynamik verschmelzen diese beiden unabhängigen Flüssigkeitsströme zu einem einzigen stärkeren, sobald sie ein Hindernis berühren.

#### TRAN CANULA®, TC- 01, CHARAKTERISTIKA

- Kennzeichen : TC- 01
- Kanülenlänge : 19 mm
- Krümmungsradius : 25 mm
- Aussendurchmesser : 0.8 mm
- Entwurf : Dr. V.T. Tran

#### TRAN CANULA® VERPACKUNG

- In einer doppelten sterilen Sichtverpackung ; zum einmaligen Gebrauch.
- Packung : 5 Stück
- 205 x 57 x 45 mm



|              |   |         |
|--------------|---|---------|
| <b>CR01</b>  | CURETTE SMALL                                       | page 41 |
| <b>CR02</b>  | CURETTE MEDIUM                                      | page 41 |
| <b>CR03</b>  | CURETTE LARGE                                       | page 41 |
| <b>CR05</b>  | CURETTE DOUBLE ENDED                                | page 41 |
| <b>CS01</b>  | CHALAZION CLAMP SMALL                               | page 41 |
| <b>CS02</b>  | CHALAZION CLAMP LARGE                               | page 41 |
| <b>CS03</b>  | CHALAZION CLAMP MEDIUM                              | page 40 |
| <b>PD01</b>  | PUNCTAL DILATOR SHARP                               | page 46 |
| <b>PD02</b>  | PUNCTAL DILATOR BLUNT                               | page 45 |
| <b>PD03</b>  | PUNCTAL DILATOR DOUBLE ENDED                        | page 46 |
| <b>PD04</b>  | PUNCTAL DILATOR SHORT                               | page 46 |
| <b>PD05</b>  | BOWMANS PROBE SIZE 00-0 DOUBLE ENDED                | page 45 |
| <b>PD06</b>  | BOWMANS PROBE SIZE 000-00 DOUBLE ENDED              | page 45 |
| <b>PD07</b>  | PUNCTAL DILATOR & LACRIMAL PROBE DOUBLE ENDED       | page 46 |
| <b>PD08</b>  | LACRIMAL PROBE                                      | page 45 |
| <b>SA11</b>  | WESTCOTT CONJUCTIVAL SCISSORS                       | page 33 |
| <b>SA12</b>  | MOORFIELDS FORCEPS                                  | page 14 |
| <b>SA13</b>  | STALLARD CORNEAL SCISSORS                           | page 33 |
| <b>SA14</b>  | WESCOTT SCISSORS DOLPHIN NOSE                       | page 34 |
| <b>SA17</b>  | MOORFIELDS FORCEPS FINE                             | page 14 |
| <b>SC01</b>  | BROAD GAUGE WIRE SPECULUM                           | page 26 |
| <b>SC03</b>  | BANGERTER ADULT SPECULUM                            | page 28 |
| <b>SC05</b>  | KRATZ SOLID BLADED WIRE SPECULUM                    | page 28 |
| <b>SC07</b>  | CLOSED LOOP WIDE SPECULUM                           | page 26 |
| <b>SC08</b>  | SOLID BLADED SCREW ADJUSTABLE SPECULUM              | page 29 |
| <b>SC09</b>  | KRATZ BARRAQUER CLOSED LOOP                         | page 26 |
| <b>SC10</b>  | KRATZ PAEDIATRIC CLOSED LOOP 10 MM SPECULUM         | page 30 |
| <b>SC95</b>  | CHOPPER AND KUGLEN HORIZONTAL DOUBLE ENDED          | page 24 |
| <b>SC100</b> | GOVAN MANIPULATOR                                   | page 19 |
| <b>SC101</b> | PISACANO ROTATOR AND NEUHANN MANIPULATOR DOUBLE END | page 23 |
| <b>SC102</b> | GOVAN MANIPULATOR AND PHACO CHOPPER                 | page 20 |
| <b>SC103</b> | NEONATE PAEDIATRIC SPECULUM                         | page 30 |
| <b>SC104</b> | DENIS SCLERECTOMY FORCEPS                           | page 13 |

|               |   |         |
|---------------|---|---------|
| <b>SC105</b>  | TROUTMAN TYING FORCEPS CURVED                   | page 17 |
| <b>SC106</b>  | LE BUISSON MANIPULATOR                          | page 21 |
| <b>SC107</b>  | KRATZ OPEN LOOP WIRE SPECULUM (BLUE)            | page 26 |
| <b>SC108</b>  | VANNAS SCISSORS CURVED                          | page 33 |
| <b>SC109</b>  | OSHER SCISSORS                                  | page 32 |
| <b>SC11</b>   | KRATZ BARRAQUER WIRE SPECULUM OPEN LOOP         | page 27 |
| <b>SC110</b>  | CASTROVIEJO SCISSORS STRAIGHT & ROUND           | page 32 |
| <b>SC111</b>  | CASTROVIEJO SCISSORS STRAIGHT                   | page 34 |
| <b>SC112</b>  | IOL REMOVAL FORCEPS                             | page 15 |
| <b>SC113</b>  | ADSONS FORCEPS FINE SERRATED                    | page 13 |
| <b>SC114</b>  | NEEDLE HOLDER CURVED                            | page 43 |
| <b>SC115</b>  | FINE CLAW FORCEPS                               | page 11 |
| <b>SC116</b>  | IRIS FORCEPS                                    | page 11 |
| <b>SC117</b>  | JAYLES FORCEPS                                  | page 12 |
| <b>SC118</b>  | CASTROVIEJO NEEDLE HOLDER LOCKING               | page 43 |
| <b>SC119</b>  | ADSONS FORCEPS                                  | page 13 |
| <b>SC12</b>   | TEMPORAL SPECULUM                               | page 28 |
| <b>SC120</b>  | SUTURE REMOVAL FORCEPS CURVED                   | page 17 |
| <b>SC121</b>  | LIEBERMAN ADJUSTABLE SPECULUM, STAINLESS STEEL  | page 28 |
| <b>SC124</b>  | HEAVY GAUGE WIRE SPECULUM OPEN LOOP             | page 26 |
| <b>SC126</b>  | CLARKE SPECULUM                                 | page 29 |
| <b>SC127</b>  | EPILATION FORCEPS                               | page 14 |
| <b>SC128</b>  | IRIS FORCEPS POINTED                            | page 11 |
| <b>SC129</b>  | BONN FORCEPS                                    | page 10 |
| <b>SC13</b>   | KRATZ CLOSED LOOP SPECULUM                      | page 24 |
| <b>SC130</b>  | CORNEAL MARKER CAPSULORHEXIS GUIDE              | page 54 |
| <b>SC132</b>  | KRATZ BARRAQUER CLOSED LOOP SPECULUM            | page 27 |
| <b>SC133M</b> | MICS CAPSULORHEXIS FORCEPS STRAIGHT             | page 7  |
| <b>SC134M</b> | MICS CAPSULORHEXIS FORCEPS ROUND BODIED CURVED  | page 7  |
| <b>SC14</b>   | PAEDIATRIC 6 MM SPECULUM                        | page 30 |
| <b>SC142</b>  | BARRAQUER NEEDLE HOLDER CURVED                  | page 43 |
| <b>SC143</b>  | KOCH PHACO SPATULA                              | page 21 |
| <b>SC144</b>  | SINSKEY HOOK AND GOVAN MANIPULATOR DOUBLE ENDED | page 23 |

|              |   |         |
|--------------|---|---------|
| <b>SC146</b> | LESTER HOOK   | page 22 |
| <b>SC147</b> | PHACO CHOPPER AND MUSHROOM MANIPULATOR DOUBLE ENDED | page 22 |
| <b>SC148</b> | NAGAHARA CLEAVER                                    | page 24 |
| <b>SC15</b>  | NEONATE 4 MM SPECULUM                               | page 30 |
| <b>SC150</b> | WIRE SPECULUM OPEN LOOP                             | page 27 |
| <b>SC19</b>  | STRAIGHT TYING FORCEPS                              | page 16 |
| <b>SC20</b>  | COLIBRI TYING FORCEPS                               | page 10 |
| <b>SC21</b>  | STRAIGHT TOOTHED FORCEPS FINE                       | page 12 |
| <b>SC22</b>  | COLIBRI TOOTHED FORCEPS                             | page 10 |
| <b>SC23</b>  | SCLERAL DEPRESSOR BULBOUS END                       | page 57 |
| <b>SC24</b>  | SCLERAL DEPRESSOR HAMMER END                        | page 57 |
| <b>SC25</b>  | SCLERAL DEPRESSOR DOUBLE ENDED                      | page 57 |
| <b>SC29M</b> | MICS CAPSULORHEXIS FORCEPS CURVED                   | page 7  |
| <b>SC33M</b> | MICS CAPSULORHEXIS FORCEPS CROSS ACTION             | page 6  |
| <b>SC34M</b> | CAPSULORHEXIS ROUND BODIED CURVED                   | page 7  |
| <b>SC35</b>  | SWAN NECK TYPE PLAIN FORCEPS                        | page 9  |
| <b>SC38</b>  | BONN FORCEPS  | page 10 |
| <b>SC39</b>  | CHOPPER AND DIALLER                                 | page 19 |
| <b>SC41</b>  | Y SHAPED NUCLEUS ROTATOR                            | page 23 |
| <b>SC42</b>  | PHACO CHOPPER CLAW                                  | page 22 |
| <b>SC43</b>  | PHACO CHOPPER                                       | page 22 |
| <b>SC44</b>  | KOCH CHOPPER  | page 20 |
| <b>SC45</b>  | GREENS CHOPPER                                      | page 19 |
| <b>SC46</b>  | LENS DIALER (SINSKEY HOOK)                          | page 21 |
| <b>SC47</b>  | DRYSDALE NUCLEUS SPATULA                            | page 24 |
| <b>SC48</b>  | MUSHROOM NUCLEUS MANIPULATOR                        | page 23 |
| <b>SC49</b>  | STRAIGHT NOTCHED FORCEPS (HOSKINS)                  | page 12 |
| <b>SC50</b>  | CURVED NOTCHED FORCEPS                              | page 16 |
| <b>SC51</b>  | LENS FOLDING FORCEPS                                | page 15 |
| <b>SC52</b>  | LENS IMPLANTATION FORCEPS                           | page 15 |
| <b>SC54</b>  | ST. MARTINS FORCEPS                                 | page 12 |
| <b>SC55</b>  | HOSKINS FORCEPS                                     | page 11 |
| <b>SC56</b>  | BISHOPS FORCEPS                                     | page 9  |

|             |   |         |
|-------------|---|---------|
| <b>SC58</b> | EPIRATION - CILIA FORCEPS                 | page 13 |
| <b>SC59</b> | ADSONS DISSECTION FORCEPS                 | page 9  |
| <b>SC60</b> | JEWELLERS FORCEPS                         | page 14 |
| <b>SC61</b> | SUTURE NEEDLE HOLDER CURVED               | page 42 |
| <b>SC62</b> | NEEDLE HOLDER BLUNT LOCK                  | page 43 |
| <b>SC63</b> | IRIS REPOSITOR                            | page 20 |
| <b>SC65</b> | MENDEZ GAUGE                              | page 39 |
| <b>SC71</b> | STRAIGHT TYING FORCEPS                    | page 17 |
| <b>SC72</b> | MC PHERSON TYING FORCEPS                  | page 16 |
| <b>SC73</b> | KELMAN MC PHERSON FORCEPS                 | page 16 |
| <b>SC80</b> | ONG IRIS SCISSORS                         | page 32 |
| <b>SC81</b> | VANNAS SCISSORS                           | page 33 |
| <b>SC82</b> | CASTROVIEJO CORNEAL SCISSORS RIGHT        | page 32 |
| <b>SC83</b> | CASTROVIEJO CORNEAL SCISSORS LEFT         | page 32 |
| <b>SC90</b> | JONES CHOPPER                             | page 20 |
| <b>SC91</b> | CHAVASSE HOOK                             | page 55 |
| <b>SC96</b> | IRIS SCISSORS                             | page 36 |
| <b>SC97</b> | DENIS CLEAVER                             | page 19 |
| <b>SC99</b> | LINDGREN FORCEPS                          | page 17 |
| <b>SG01</b> | GENERAL SCISSORS SHARP POINTED            | page 35 |
| <b>SG02</b> | MOSQUITO FORCEPS                          | page 15 |
| <b>SG03</b> | TRABECULECTOMY PUNCH                      | page 58 |
| <b>SG04</b> | BRAUNSTEIN FIXED CALIPER 1.8 MM THICKNESS | page 38 |
| <b>SG05</b> | CASTROVIEJO ADJUSTABLE CALIPER            | page 38 |
| <b>SG06</b> | GENERAL SCISSORS BLUNT END                | page 35 |
| <b>SG07</b> | STRABISMUS SCISSORS                       | page 36 |
| <b>SG10</b> | JAMESON STRABISMUS HOOK 5 MM              | page 56 |
| <b>SG11</b> | JAMESON HOOK                              | page 58 |
| <b>SG12</b> | THORNTON FIXATION RING SMALL 13 MM        | page 54 |
| <b>SG13</b> | THORNTON FIXATION RING STANDARD 16 MM     | page 58 |
| <b>SG14</b> | GENERAL LONG HANDLE SCISSORS BLUNT END    | page 35 |
| <b>SG15</b> | KUGLEN HOOK                               | page 21 |
| <b>SG17</b> | EYELID PLATE                              | page 56 |

|              |   |         |
|--------------|---|---------|
| <b>SG19</b>  | SCLERAL MARKER ROUND BODIED DOUBLE ENDED        | page 39 |
| <b>SG20</b>  | DESMARRES RETRACTOR                             | page 55 |
| <b>SG22</b>  | MOSQUITO FORCEPS CURVED                         | page 57 |
| <b>SG23</b>  | STEVENS SCISSORS CURVED                         | page 36 |
| <b>SG28</b>  | GILLIES HOOK SMALL                              | page 58 |
| <b>SG30</b>  | METZENBAUM SCISSORS CURVED POINTED              | page 35 |
| <b>SG32</b>  | BALL TIP MUSCLE HOOK                            | page 55 |
| <b>SG33</b>  | HALSTEAD MOSQUITO FORCEPS STRAIGHT              | page 56 |
| <b>SG34</b>  | ENUCLEATION SCISSORS                            | page 34 |
| <b>SG35</b>  | DRESSING SCISSORS                               | page 34 |
| <b>SG37</b>  | GUTHRIE HOOK                                    | page 56 |
| <b>SG92</b>  | BULLDOG CLIP                                    | page 55 |
| <b>SG93</b>  | HELVESTON RULER                                 | page 38 |
| <b>SR01</b>  | LENTICULE EXTRACTION FORCEPS                    | page 54 |
| <b>SR02</b>  | LASIK FEMTO SEPERATOR AND ELEVATOR DOUBLE ENDED | page 52 |
| <b>SR03</b>  | SINSKEY AND REVERSE SINSKEY HOOK                | page 52 |
| <b>SR04</b>  | CORNEAL RING PUSHER                             | page 52 |
| <b>SR05</b>  | CORNEAL RING POCKETING HOOK                     | page 52 |
| <b>SR06</b>  | CORNEAL RING POCKET SPREADER                    | page 53 |
| <b>SR07</b>  | CORNEAL RING FORCEPS KERARING                   | page 53 |
| <b>SR08</b>  | CORNEAL RING FORCEPS INTACS                     | page 53 |
| <b>SR10</b>  | BLADED ADJUSTABLE SPECULUM                      | page 29 |
| <b>SR100</b> | CORNEAL EPITHELIUM SPATULA ROUND                | page 48 |
| <b>SR101</b> | S MARKER  | page 51 |
| <b>SR102</b> | KOCABA DMEK FORCEPS                             | page 49 |
| <b>SR103</b> | LASIK FLAP SEPERATOR AND ELEVATOR DOUBLE END    | page 51 |
| <b>SR104</b> | LENTICULE SEPERATOR HOOK AND SPATULA DOUBLE END | page 51 |
| <b>SR105</b> | TREPHINE VARIOUS SIZES                          | page 51 |
| <b>SR108</b> | PATON SPATULA & SPOON DOUBLE ENDED              | page 53 |
| <b>SR109</b> | DMEK BERNHEIM HOOK                              | page 48 |
| <b>SR11</b>  | KRATZ SCREW ADJUSTABLE WIRE SPECULUM OPEN LOOP  | page 27 |
| <b>SR14</b>  | LASIK FLAP-LIFTING FORCEPS                      | page 47 |
| <b>SR21</b>  | LASIK CORNEAL MARKER                            | page 50 |

|              |                               |         |
|--------------|-------------------------------|---------|
| <b>SR31</b>  | LASIK FLAP ELEVATOR           | page 50 |
| <b>SR34</b>  | INTRA LASIK FLAP SEPARATOR    | page 49 |
| <b>SR40</b>  | CK LASIK MARKER               | page 48 |
| <b>SR41</b>  | ALCOHOL WELL VARIOUS SIZES    | page 50 |
| <b>SR51</b>  | EPI PEELER                    | page 48 |
| <b>SR60</b>  | EPI PEELER D SHAPED           | page 49 |
| <b>SR61</b>  | EPI PEELER RECTANGLE SHAPED   | page 49 |
| <b>SR70</b>  | REINSTEIN LENTICULE SEPARATOR | page 47 |
| <b>SR71</b>  | LASIK FLAP FORCEPS            | page 50 |
| <b>SR72</b>  | 8 LINE CORNEAL MARKER         | page 39 |
| <b>TC-01</b> | TRAN CANULA                   | page 60 |

Ces produits sont des dispositifs médicaux de classe IIa - CE0197 pour les dispositifs fabriqués par Surgitrac Instruments (mandataire européen Alvena, Malte) et CE0123 pour les dispositifs fabriqués par Fabrial.

Distributed by:

**salensa**  
Gabriele Sadlowski e.K.

Fuggerstraße 1a  
D-88142 Wasserburg

Telefon +49 (0) 83 82/94 30 225  
Telefax +49 (0) 83 82/94 30 226

vertrieb@salensa.de  
www.salensa.de  
www.salensa-shop.de

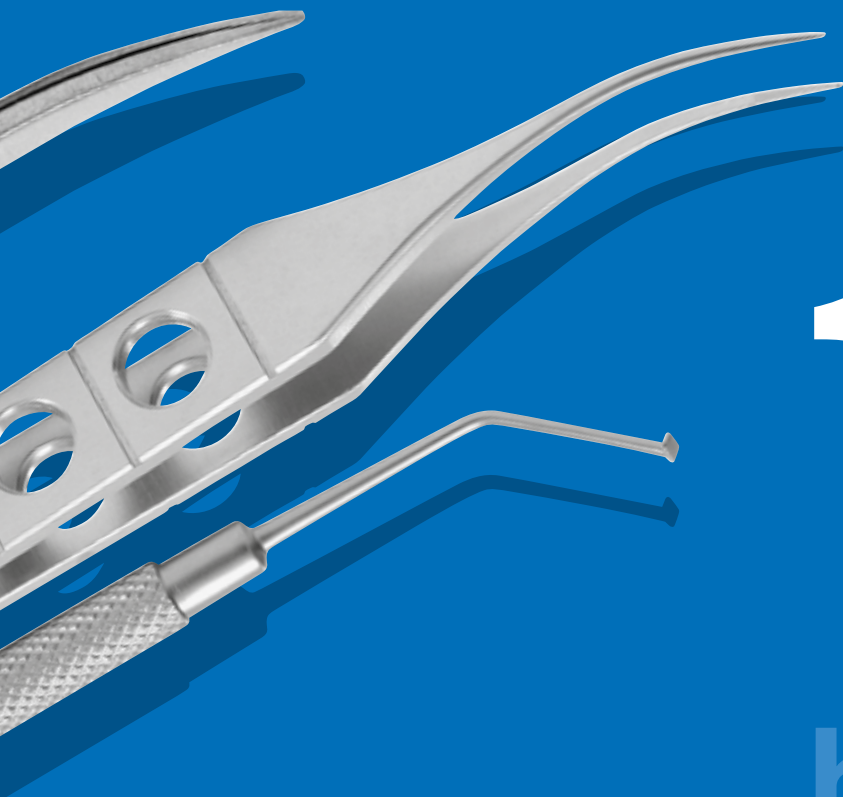

**1** **J** **JUST**  
**ONE**  
**USE**

by **Surgitrac**  
Europe

2 RUE HÉLÈNE BOUCHER  
35235 THORIGNÉ-FOUILLARD  
Tel +33(0)970.460.790  
.....  
www.just-one-use.com